

High-pressure In-line Pump

# Movitec

50 Hz

## Type Series Booklet



## **Legal information/Copyright**

Type Series Booklet Movitec

All rights reserved. The contents provided herein must neither be distributed, copied, reproduced, edited or processed for any other purpose, nor otherwise transmitted, published or made available to a third party without the manufacturer's express written consent.

Subject to technical modification without prior notice.

© KSB SE & Co. KGaA, Frankenthal 27/05/2021

## Contents

<b>High-pressure Pumps</b> .....	<b>5</b>
High-pressure In-line Pumps.....	5
Movitec.....	5
Main applications.....	5
Fluids handled.....	5
Operating data.....	5
Design details.....	5
Designation.....	7
Materials.....	10
Coating and preservation.....	10
Product benefits.....	10
Product information.....	11
Product information as per Regulation No. 1907/2006 (REACH).....	11
Product information as per Regulation No. 547/2012 (for water pumps with a maximum shaft power of 150 kW) implementing "Ecodesign" Directive 2009/125/EC.....	11
Certifications.....	11
Acceptance tests and warranty.....	11
Selection information.....	12
Impeller for lower NPSH values.....	12
Information about the characteristic curve.....	13
Fluid handled.....	14
Minimum flow rate and maximum flow rate.....	14
Overview of product features / selection tables.....	15
Overview of fluids handled.....	15
Shaft seal.....	18
Technical data.....	20
Motors.....	20
Types of connection.....	21
Selection charts.....	22
Movitec, n = 2900 rpm.....	22
Movitec, n = 1450 rpm.....	23
Characteristic curves.....	24
n = 2900 rpm.....	25
Movitec 2B, n = 2900 rpm.....	25
Movitec 25B, n = 2900 rpm.....	26
Movitec 4B, n = 2900 rpm.....	27
Movitec 4LB, n = 2900 rpm.....	28
Movitec 6B, n = 2900 rpm.....	29
Movitec 6LB, n = 2900 rpm.....	30
Movitec 10B, n = 2900 rpm.....	31
Movitec 10LB, n = 2900 rpm.....	32
Movitec 15C, n = 2900 rpm.....	33
Movitec 15LC, n = 2900 rpm.....	34
Movitec 25B, n = 2900 rpm.....	35
Movitec 40B, n = 2900 rpm.....	36
Movitec 60B, n = 2900 rpm.....	37
Movitec 90B; n = 2900 rpm.....	38
Movitec 125B, n = 2900 rpm.....	39
Movitec LHS, n = 2900 rpm.....	40
n = 1450 rpm.....	41
Movitec 10B, n = 1450 rpm.....	41
Movitec 10LB, n = 1450 rpm.....	42
Movitec 15C, n = 1450 rpm.....	43
Movitec 15LC, n = 1450 rpm.....	44
Movitec 25B, n = 1450 rpm.....	45
Movitec 40B, n = 1450 rpm.....	46
Movitec 60B, n = 1450 rpm.....	47
Movitec 90B, n = 1450 rpm.....	48
Dimensions and connections.....	49
Movitec 2(L)B, n = 2900 rpm.....	49
Movitec 4(L)B, n = 2900 rpm.....	50
Movitec 6(L)B, n = 2900 rpm.....	51

Movitec 10(L)B, n = 1450 rpm.....	52
Movitec 10(L)B, n = 2900 rpm.....	53
Movitec 15(L)C, n = 1450 rpm.....	54
Movitec 15(L)C, n = 2900 rpm.....	55
Movitec 25B , n = 1450 rpm.....	56
Movitec 25B, n = 2900 rpm.....	57
Movitec 40B, n = 1450 rpm.....	58
Movitec 40B, n = 2900 rpm.....	59
Movitec 60B, n = 1450 rpm.....	60
Movitec 60B, n = 2900 rpm.....	61
Movitec 90B, n = 1450 rpm.....	62
Movitec 90B, n = 2900 rpm.....	63
Movitec 125B, n = 2900 rpm.....	64
Movitec LHS, n = 2900 rpm.....	65
Installation information.....	66
Terminal box positions.....	68
Scope of supply .....	68
Accessories.....	68
Accessories.....	68
General assembly drawing with list of components.....	69
Movitec 2(L)B, 4(L)B, 6(L)B.....	69
Movitec 10(L)B.....	70
Movitec 15(L)C.....	71
Movitec 25B, 40B, 60B.....	72
Movitec 90B.....	73
Movitec 125B.....	75
Movitec LHS.....	77

## High-pressure Pumps

### High-pressure In-line Pumps

## Movitec



**i** The product illustrated as an example may include options incurring a surcharge.

#### Main applications

- Spray irrigation systems
- General irrigation systems
- Washing plants
- Fire-fighting systems
- Pressure boosting
- Industrial plants
- Water supply systems
- Heating, ventilation and air-conditioning systems
- Marine applications

#### Fluids handled

- High-temperature hot water
- Clear water
- Condensate
- Cooling water
- Fire-fighting water
- Oil
- Cleaning agents
- And others (⇒ Page 15)

#### Operating data

Table 1: Operating properties

Characteristic		Value	
		Movitec LHS	Movitec V, VS, VC
Flow rate	Q [m <sup>3</sup> /h]	≤ 8,6	≤ 160
	Q [l/s]	≤ 2,4	≤ 44,4
Head	H [m]	≤ 401	≤ 249
Fluid temperature	T [°C]	≥ -15	≥ -20
		≤ +120	≤ +140 <sup>1)</sup>
Operating pressure	p [bar]	≤ 40 <sup>2)</sup>	≤ 40 <sup>2)</sup>

#### Design details

##### Design

- High-pressure in-line pump
- Maximum pressure class PN 40
- Centrifugal pump
- Single-stage or multistage

##### Installation

- Horizontal installation / vertical installation

##### Drive

- Surface-cooled KSB squirrel-cage motor
- 3~230/400 V up to 2.2 kW
- 3~400/690 V from 3.0 kW
- Thermal class F to IEC 34-1
- Efficiency class IE3 to IEC 60034-30 (for three-phase motors ≥ 0.75 kW)
- Enclosure IP55
- Frequency 50 Hz

##### Automation

Automation options:

- PumpDrive
- PumpMeter

##### Shaft seal

- Uncooled maintenance-free mechanical seal
- To EN 12756
- Fixed mechanical seal
  - Mechanical seal in standard design
  - Unbalanced bellows-type seal
  - ≤ 25 bar
  - Available up to size 15

<sup>1</sup> For fluid temperatures > 120 °C the pressure class must not exceed PN 25.

<sup>2</sup> The sum of inlet pressure and shut-off head must not exceed the value indicated.

- Easy Access mechanical seal
  - Easy to replace
  - Unbalanced bellows-type seal
  - $\leq 25$  bar
  - Drive lantern need not be removed to replace the seal.
  - Motor rating 5.5 kW and above: Motor need not be removed.
  - Available up to size 90<sup>3)</sup>
- Cartridge seal
  - Unbalanced bellows-type design (PN 25) or special balanced design (PN 40)
  - Drive lantern need not be removed to replace the seal.
  - Motor rating 5.5 kW and above: Motor need not be removed.
  - Optionally available for all sizes except Movitec LHS
  - Available for all sizes

### Bearings

- Product-lubricated stage bearing (tungsten carbide / aluminium oxide)

---

<sup>3</sup> With the exception of variant LHS

---

**Designation**
**Table 2:** Designation example

Position																															
1	2	3	4	5	6	7	8	9	10	11	12	13	14	15	16	17	18	19	20	21	22	23	24	25	26	27	28	29	30	31	32
M	o	v	i	t	e	c	V	-	F	0	0	6	/	0	6	1	B	3	D	1	3	E	S	1	1	2	B	7	D	A	X
See name plate and data sheet																		See data sheet													

**Table 3:** Designation key

Position	Code	Description
1-7	Type series	
	Movitec	
8-9	Design	
	LH	Stainless steel 1.4404
	V	Stainless steel 1.4301
	VC	Stainless steel / grey cast iron 1.4301 / EN-GJL-250
	VM	Stainless steel 1.4301
	VS	Stainless steel 1.4404
10	Connection type	
	<sup>4)</sup>	Oval flange
	E <sup>5)</sup>	External thread
	F	Round flange
	I	Internal thread
	T	Tri-Clamp fitting
	V	Victaulic coupling
11-13	Size	
	002	2
	...	...
	125	125
15-16	Number of stages	
	01	1
	...	...
	30	30
17	Number of stages with special impeller	
	-	No stage with a special impeller
	1	One stage with a special impeller
	2	Two stages with a special impeller
	L	One stage with a special impeller for lower NPSH values
18	Product generation	
	A	Movitec up to 2009
	B	Movitec since 2010
	C	Movitec since 2021
19	Connection standard	
	0	Victaulic coupling No standard
	1	Round flange EN 1092
	2	Round flange ASME B16.1
	3	Round flange JIS B2238
	4	Oval flange EN ISO 228-1
	5	Oval flange ASME B16.5
	6	Tri-Clamp fitting DIN 32676
	7	External thread EN ISO 228-1
	8	Oval flange ISO 7-1
	9	Round flange ASME B16.5
20	Material variant	
	D	1.4308 - EN-GJS-400-15 - EN-GJL-250
	E	1.4308 - EN-GJS-400-15 - 1.4308
	F	1.4308 - 1.4308 - EN-GJL-250

<sup>4</sup> Blank

<sup>5</sup> Pumps with external thread are supplied with an integrated swing check valve as standard.

Position	Code	Description
20	G	1.4308 - 1.4308 - EN-GJS-400-15
	H	1.4308 - 1.4308 - 1.4308
	K	1.4308 - 1.4408 - EN-GJS-400-15
	L	1.4308 - 1.4408 - EN-GJL-250
	M	1.4308 - 1.4408 - 1.4308
	N	1.4308 - EN-GJS-400-15 - EN-GJL-250
	O	1.4408 - EN-GJS-400-15 - 1.4308
	P	1.4408 - 1.4308 - EN-GJL-250
	Q	1.4408 - 1.4308 - 1.4308
	R	1.4408 - 1.4408 - EN-GJL-250
	S	1.4408 - 1.4408 - EN-GJS-400-15
	T	1.4408 - 1.4408 - 1.4308
	U	EN-GJL-250 - EN-GJL-250 - EN-GJL-250
	V	EN-GJS-400-15 - EN-GJS-400-15 - EN-GJS-400-15
	W	EN-GJS-400-15 - 1.4308 - EN-GJS-400-15
	X	1.4308 - EN-GJS-400-15 - EN-GJS-400-15
	Y	1.4408 - EN-GJS-400-15 - EN-GJS-400-15
Z	1.4408 - 1.4308 - EN-GJS-400-15	
21-22	Seal code	
	11	BQ1EGG
	12	BQ1VGG
	13	Q1BEGG
	14	Q1BVGG
	15	U3U3X4GG
	16	U3U3VGG
	17	U3BVGG <sup>6)</sup>
	18	U3BEGG
	19	U3BEGG <sup>6)</sup>
	20	Q1AEGG
	21	Q1AVGG
	22	Q1AX4GG
	23	Q1BEGG
	24	Q1Q1VGG
	28	Q1Q1X4GG
	29	Q1Q1EGG
	35	eCarb-B eSic-Q7EGG
	36	eCarb-B eSic-Q7VGG
	37	U3AVGG
	40	Q1Q1EGG
41	Q1AEGG	
42	Q1Q1VGG	
43	Q1AVGG	
23	Mechanical seal design	
	F	Fixed mechanical seal
	E	Easy Access mechanical seal
	C	Cartridge seal
24	Drive	
	0	Without motor
	2	With PumpDrive 2
	A	ATEX IEC
	E	With PumpDrive 2 Eco
	N	Standard NEMA
	S	Standard IEC
25-27	Motor size	
	056	NEMA 56C
	071	IEC 071

<sup>6</sup> For Movitec LHS only



Position	Code	Description
25-27	080	IEC 080
	090	IEC 090
	100	IEC 100
	112	IEC 112
	132	IEC 132
	143	NEMA 143TC
	145	NEMA 145TC
	160	IEC 160
	180	IEC 180
	182	NEMA 182TC
	184	NEMA 184TC
	200	IEC 200
	215	NEMA 215TC
	225	IEC 225
	256	NEMA 256TC
	284	NEMA 284TC
	286	NEMA 286TC
324	NEMA 324TC	
326	NEMA 326TC	
364	NEMA 364TC	
28	Pressure class	
	A	PN16 / PN25
	B	PN25
	C	PN25 / PN40
	D	PN40
29	Frequency, number of motor poles	
	5	50 Hz, 2-pole
	6	60 Hz, 2-pole
	7	50 Hz, 4-pole
	8	60 Hz, 4-pole
30	Motor specification	
	F	EXM IEC - TBH
	G	EXM NEMA
	K	EXM IEC - Movitec
	M	230 V, single-phase AC motor
	O	0.37 / 0.55 kW, without IE classification
	U	230 / 400 V - IE3
	V	400 / 690 V - IE3
	W	230 / 400 V - IE4/IE5 (KSB SuPremE)
	X	400 / 690 V - IE4/IE5 (KSB SuPremE)
31	PumpMeter	
	A	With PumpMeter
	W	Without PumpMeter
32	Design	
	<sup>-4)</sup>	Standard
	X	Non-standard (BT3D, BT3)

**Materials**
**Table 4: Overview of available materials**

Part No.	Description	Design			
		V	VC	VS	LHS
10-6	Pump shroud	1.4301		1.4404	
101	Pump casing	1.4308	EN-GJL-250 <sup>7)</sup> / EN-GJS-400-15 <sup>8)</sup>	1.4408	
108	Stage casing	1.4301 <sup>9)</sup> / 1.4308 <sup>10)</sup>		1.4404 <sup>9)</sup> / 1.4408 <sup>10)</sup>	
160	Discharge cover	1.4301 <sup>9)</sup> / 1.4308 <sup>10)</sup>		1.4404 <sup>9)</sup> / 1.4408 <sup>10)</sup>	
210	Shaft	1.4057		1.4460 / 1.4401 <sup>11)</sup>	
230	Impeller <sup>12)</sup>	1.4301 <sup>9)</sup> / 1.4308 <sup>10)</sup>		1.4404 <sup>9)</sup> / 1.4408 <sup>10)</sup>	
341	Drive lantern	EN-GJL-250 <sup>13)</sup> / EN-GJS-400-15 <sup>14)</sup>			
412	O-ring	EPDM-WRc / ACS	EPDM	FPM / HNBR	
525	Spacer sleeve	1.4301		1.4401	
529	Bearing sleeve	Tungsten carbide / aluminium oxide			
890	Baseplate	EN-GJS-400-15 / EN-GJL-250 / 1.4308 <sup>15)</sup>	-	EN-GJS-400-15 / EN-GJL-250 / 1.4308 <sup>15)</sup>	
905	Tie bolt	1.4057			
920	Nut	1.4301		1.4404	
932	Circlip	1.4571			

**Table 5: Comparison of materials**

EN	ASTM
EN-GJL-250	A48 Class 35 B
EN-GJS-400-15	A536 Grade 60-40-18
1.4057	SS 431 (UNS S43100)
1.4301	SS 304 (UNS S30400)
1.4308	Grade CF8 (J92600)
1.4401	SS 316 (UNS S31600)
1.4404	SS 316L (UNS S31603)
1.4408	Grade CF8M (UNS J92900)
1.4460	SS 329 (UNS S32900)
1.4571	SS 316 Ti (UNS S31635)

**Coating and preservation**
**Table 6: Coating of pump components**

Component	Coating
Stainless steel components	No additional coating
<b>Movitec VC:</b>	
Pump casing made of grey cast iron	Cataphoretic coating
<b>Movitec V/VS:</b>	
Slide flanges made of grey cast iron	Cataphoretic coating
Drive lantern made of grey cast iron	Powder coating

**Product benefits**

- Reliable: product-lubricated plain bearings made of tungsten carbide, cast pump foot, torsion-resistant pump shroud and confined O-rings
- Long service life: corrosion-resistant hydraulic components made of stainless steel
- Easy to service: can be fitted with any standardised mechanical seal (to EN 12756)
- Flexible: various materials and connection options, extended temperature range and pressure range

<sup>7</sup> Movitec 2B, 4B, 6B, 10B, 15B/C, 25B, 40B, 60B, 125B

<sup>8</sup> Movitec 90B

<sup>9</sup> Movitec 2B, 4B, 6B, 10B, 15B/C, 25B, 40B, 60B, 125B

<sup>10</sup> Movitec 90B, 125B

<sup>11</sup> Movitec VS 2B, 4B up to 14 stages, 6B up to 12 stages, 10B, 15B/C up to 10 stages

<sup>12</sup> The impellers of Movitec 125 are made of sheet metal and cast material.

<sup>13</sup> Movitec 2B, 4B, 6B, 10B, 15B/C, 25B ( $\leq 4$  kW) and Movitec 90B

<sup>14</sup> Movitec 2B, 4B, 6B, 10B, 15B/C, 25B ( $\geq 5.5$  kW) and Movitec 40B, 60B, 125B

<sup>15</sup> Optional for: Movitec 2B, 4B, 6B, 10B, 15B/C

## Product information

### Product information as per Regulation No. 1907/2006 (REACH)

For information as per chemicals Regulation (EC) No. 1907/2006 (REACH), see <https://www.ksb.com/ksb-en/About-KSB/Corporate-responsibility/reach/>.



### Product information as per Regulation No. 547/2012 (for water pumps with a maximum shaft power of 150 kW) implementing "Ecodesign" Directive 2009/125/EC

- Minimum efficiency index: see data sheet
- The benchmark for the most efficient water pumps is MEI  $\geq 0.70$ .
- Year of construction: see data sheet
- Manufacturer's name or trade mark, commercial registration number and place of manufacture: see data sheet or order documentation
- Product's type and size identifier: see data sheet
- Hydraulic pump efficiency (%) with trimmed impeller: see data sheet
- Pump performance curves, including efficiency characteristics: see documented characteristic curve
- The efficiency of a pump with a trimmed impeller is usually lower than that of a pump with full impeller diameter. Trimming of the impeller will adapt the pump to a fixed duty point, leading to reduced energy consumption. The minimum efficiency index (MEI) is based on the full impeller diameter.
- Operation of this water pump with variable duty points may be more efficient and economic when controlled, for example, by the use of a variable speed drive that matches the pump duty to the system.
- Information relevant for disassembly, recycling or disposal at end of life: see installation/operating manual
- Information on benchmark efficiency or benchmark efficiency graph for MEI = 0.70 (0.40) for the pump based on the model shown in the Figure are available at: <http://www.europump.org/efficiencycharts>

- Final inspection
  - Inspection certificate 3.1 to EN 10204 on request
- Hydraulic test
  - The duty point of each pump is guaranteed to ISO 9906:2012 Grade 3B.
  - This test is always carried out using the original motor. The NPSH and the suction lift are not measured (3.2 certificate available).
- Warranties
  - Warranties are given within the scope of the valid terms and conditions of sale and delivery.

## Certifications

Table 7: Overview

Label	Effective in:	Comment
	France	Approved in accordance with the French drinking water regulation
	United Kingdom	Approved in accordance with the UK drinking water regulation

## Acceptance tests and warranty

- Pressure test
  - to EN 809
- Leak test
  - with water
- Materials testing
  - Certificate of compliance with the order (corresponds to EN 10204)  
In the certificate of compliance with the order the manufacturer confirms by way of an informal report without specifying test results that the delivery complies with the stipulations of the purchase order.
  - Test report 2.2 on request

## Selection information

### Impeller for lower NPSH values

An impeller for lower NPSH values is available for sizes 2, 4, 6, 10 and 15.

This type of impeller ensures that the pump's NPSH curve is significantly improved.

The solution is based on a newly developed impeller for lower NPSH values and a modified stage casing. Cavitation inside the pump can hence be prevented in the case of critical inlet conditions.

#### Risks of cavitation:

- Reduced lifetime of the pump due to damaged parts and unbalanced hydraulic system
- Excessive wear of pump parts or motor bearings
- Insufficient cooling and/or lubrication of the mechanical seal and pump bearing

#### Benefits of using impellers for lower NPSH values:

- More suitable in critical inlet conditions
- Easy adaptation to non-optimised application parameters
- The suction lift ( $H_p$ ) is less crucial (the frame height of the degassing tank used in boiler feeding can be reduced).

#### Consequences of using impellers for lower NPSH values:

- No need to change pump installation heights or pump nozzles
- Minor adjustments to the characteristic curve

#### Calculation:

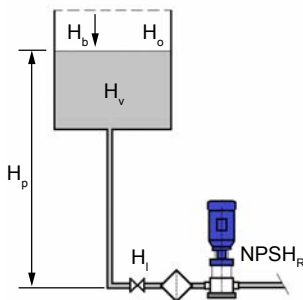

$$\begin{aligned} \text{NPSH}_A &\geq \text{NPSH}_R + H_z \\ \text{NPSH}_A &= H_b + H_o + H_p - H_v - H_l \\ x &= H_b + H_o + H_p - H_v - H_l - \text{NPSH}_R - H_z \\ x &\geq 0 \end{aligned}$$

Fig. 1: Calculating the  $\text{NPSH}_A$

$\text{NPSH}_A$	NPSH system value at operating point
$\text{NPSH}_R$	NPSH pump value at operating point (see characteristic curve of the pump)
$H_b$	Atmospheric pressure [mWc]
$H_o$	Positive pressure (with tank closed)
$H_p$	Suction lift [mWc]
$H_v$	Vapourisation pressure [mWc] (see vapourisation pressure diagram for water)
$H_l$	Friction losses in pipes and accessories [mWc]
$H_z$	Safety margin (min. 0,5 m)
x	Minimum pressure

#### Result:

If the minimum pressure (x) is positive, there is no risk of cavitation.

If the minimum pressure (x) is negative, there is a risk of cavitation which can be avoided by using an impeller for lower NPSH values.

Another option is to change one of the other values so that the value becomes positive.

#### Example:

- Boiler feed water: 105 °C
- Positive height of tank: 2 m
- Positive pressure in tank: 3 mWc
- Flow rate: 5 m<sup>3</sup>/h
- Head: 100 m (10 bar)
- Size selected: 4

**Table 8:** Calculation of positive pressure on suction flange:

Calculation of positive pressure on suction flange:	Standard impeller	Special impeller for lower NPSH values
Atmospheric pressure [mWc]	10,3	10,3
Positive pressure (with tank closed)	3,0	3,0
Suction lift	2,0	2,0
Vaporisation pressure [mWc] (see water vaporisation pressure diagram)	-12,5	-12,5
Friction losses in pipes and accessories [mWc]	-1,0	-1,0
Safety margin (min. 0,5 m)	-0,5	-0,5
NPSH pump value at operating point (see characteristic curve of the pump)	-2,1	-0,8
Minimum pressure	-0,8	+0,5
Conclusion	Cavitation will occur.	No cavitation

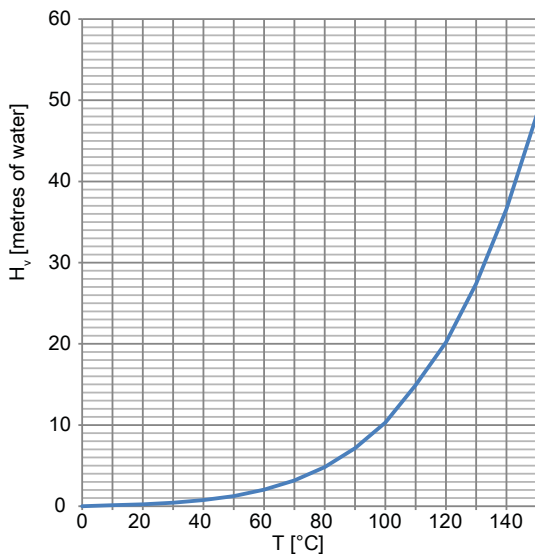

**Fig. 2:** Vaporisation pressure diagram ( $H_v$ ) for water

**Information about the characteristic curve**

NPSH [m], [ft]:

- The NPSH values given in the individual characteristic curves are minimum values which correspond to the cavitation limit.
- A safety margin of at least 0.5 m must be added when selecting the pump to compensate for measuring inaccuracies.
- The NPSH curves reflect average values.
- A safety margin of 0.5 m must be added to the NPSH value of the characteristic curve when selecting a system.

P [kW], [hp]:

- The power input is indicated per stage ( $St = 1$ ) and/or per stage with a smaller impeller ( $St = -1$ ). The pump input power can be calculated accordingly. Calculation: value indicated in the diagram ( $St = 1$ )  $\times$  number of stages + value indicated in the diagram ( $St = -1$ )  $\times$  number of stages with a smaller impeller  
 Example 1, Movitec 90/4:  $P = (St = 1) \times 4$   
 Example 2, Movitec 90/4-1:  $P = (St = 1) \times 3 + (St = -1)$   
 Example 3, Movitec 90/4-2:  $P = (St = 1) \times 2 + (St = -1) \times 2$

### Fluid handled

The actual operating conditions must always be checked (concentration, temperature, solids content). Penetration of air into the system must be avoided by all means.

If the fluid handled contains solids such as steel chips or steel chip dust, check the permissible particle concentration with KSB.

### Minimum flow rate and maximum flow rate

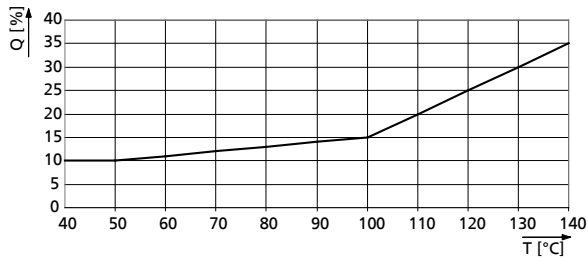

Fig. 3: Minimum flow rate required as a function of fluid temperature at a fluid temperature  $> +20\text{ °C}$

Table 9: Minimum flow rate and maximum flow rate Q at a fluid temperature  $\leq +20\text{ °C}$  depending on the number of poles

Size	Q			
	2 poles		4 poles	
	Min. [m <sup>3</sup> /h]	Max. [m <sup>3</sup> /h]	Min. [m <sup>3</sup> /h]	Max. [m <sup>3</sup> /h]
2B	0,2	3,3	-	-
4B	0,4	6,5	-	-
6B	0,6	9,0	-	-
10B	1,1 <sup>16)</sup>	13,2	0,5	6,6
15C	1,6	22,5	0,8	11,3
25B	2,8	35,0	1,4	17,5
40B	4,0	54,0	2,0	27,0
60B	6,0	76,0	3,0	38,0
90B	8,5	110,0	4,3	53,9
125B	12,2	160,0	-	-
LHS	0,8	8,6	-	-

<sup>16)</sup> For pumps with VdS certification the minimum flow rate Q<sub>min</sub> is 5 % of the permissible flow rate.

**Overview of product features / selection tables**
**Overview of fluids handled**

The data refer to the chemical resistance of the materials. The relevant regulations / standards governing individual pump applications have to be complied with.

If the operating conditions differ from the data given (e.g. mixed products) or if the fluids handled are not included in the table below, please contact the manufacturer.

- **Temperature ranges:**
  - Reference temperature: +20 °C
  - For temperatures <0 °C: contact the manufacturer.
  - For temperatures > +50 °C: check and observe the vapour pressure of the fluid handled.
  - Max. temperature = +120 °C, unless indicated otherwise.
- Max. concentration = 100 % unless indicated otherwise.
- Mechanical seal silicon carbide / carbon (Q1B): not suitable for fluids containing solid substances. This rule also covers particles developing as a result of salt crystallisation at low fluid temperatures.
- Mechanical seal tungsten carbide / tungsten carbide (U3U3): solids content max. 20 ppm (depending on particle size), with the exception of corrosive fluids. Fluids with a higher solids content are not permitted (ppm = 1 mg/kg).
- Caution: High temperatures will increase corrosion (reference temperature = +20 °C).
- Under unfavourable conditions (high temperatures, deposits, long idle periods), chloride contents of more than 300 mg/l may result in localised corrosion.

**Table 10:** Selection of pump design and mechanical seal design depending on the fluid to be handled

Fluid handled			Design																		
Substance contained	Max. percentage	T <sub>Max.</sub>	V					VC					VS					LHS			
			Seal code																		
			[%]	[°C]	13	14	15	16	18	13	14	15	16	18	23	13	14	15	16	18	17
Alum, acid-free	≤ 3	+50	-	X	-	-	-	-	-	-	-	-	-	-	-	X	-	-	-	-	-
Alum, acid-free	≤ 3	+80	-	-	-	-	-	-	-	-	-	-	-	-	-	X	-	-	-	-	-
Alkaline solution, bottle rinsing, max. 2 % sodium hydroxide	≤ 100	+40	-	-	X	-	-	-	-	X	-	-	-	-	-	X	-	-	-	-	-
Alcohol																					
▪ Butanol	≤ 100	+60	X	-	-	-	-	X	-	-	-	-	X	X	-	-	-	-	-	-	-
▪ Ethanol	≤ 100	+60	X	-	-	-	-	X	-	-	-	-	X	X	-	-	-	-	-	-	-
▪ Propanol	≤ 100	+80	X	-	-	-	-	X	-	-	-	-	X	X	-	-	-	-	-	-	-
▪ Spirits (40 % ethanol)	≤ 100	+60	X	-	-	-	-	-	-	-	-	-	-	X	-	-	-	-	-	-	-
Wine (white, red)	≤ 100	+60	X	X	-	-	-	-	-	-	-	-	-	X	X	-	-	-	-	X	X
Tartaric acid	≤ 100	+60	-	-	-	-	-	-	-	-	-	-	-	-	-	-	-	-	-	X	-
Ammonium bicarbonate	≤ 10	+40	X	-	-	-	-	X	-	-	-	-	X	X	-	-	-	-	-	-	-
Aluminium sulphate, acid-free	≤ 5	+50	-	-	-	X	-	-	-	-	-	-	-	-	-	-	-	X	-	-	-
Aluminium sulphate, acid-free	≤ 5	+60	-	-	-	-	-	-	-	-	-	-	-	-	-	-	-	X	-	-	-
Ammonium sulphate	≤ 20	+60	X	-	-	-	-	-	-	-	-	-	-	X	-	-	-	-	-	-	-
Calcium acetate, acid-free	≤ 10	+60	X	-	-	-	-	X	-	-	-	-	X	X	-	-	-	-	-	-	-
Calcium nitrate, acid-free	≤ 10	+60	-	-	-	X	-	-	-	-	-	-	-	-	-	-	-	X	-	-	-
Ferric sulphate (II)	≤ 5	+80	-	-	-	X	-	-	-	-	-	-	-	-	-	-	-	X	-	-	-
Water-oil emulsion (95 %, 5 %), free of solids	≤ 100	+80	-	X	-	-	-	-	X	-	-	-	-	-	-	X	-	-	-	-	-
Ethylene glycol base antifreeze, inhibited, closed system	≤ 20	+110	X <sup>17)</sup>	X	-	X	-	X <sup>17)</sup>	X	-	X	-	X <sup>17)</sup>	X <sup>17)</sup>	X	-	X	-	-	-	-
	≤ 25	+110	X <sup>17)</sup>	X	-	X	-	X <sup>17)</sup>	X	-	X	-	X <sup>17)</sup>	X <sup>17)</sup>	X	-	X	-	-	-	-
	≤ 30	+110	X <sup>17)</sup>	X	-	X	-	X <sup>17)</sup>	X	-	X	-	X <sup>17)</sup>	X <sup>17)</sup>	X	-	X	-	-	-	-
	≤ 35	+110	X <sup>17)</sup>	X	-	X	-	X <sup>17)</sup>	X	-	X	-	X <sup>17)</sup>	X <sup>17)</sup>	X	-	X	-	-	-	-
	≤ 40	+110	X <sup>17)</sup>	X	-	X	-	X <sup>17)</sup>	X	-	X	-	X <sup>17)</sup>	X <sup>17)</sup>	X	-	X	-	-	-	-
	≤ 45	+110	X <sup>17)</sup>	X	-	X	-	X <sup>17)</sup>	X	-	X	-	X <sup>17)</sup>	X <sup>17)</sup>	X	-	X	-	-	-	-
	≤ 50	+110	X <sup>17)</sup>	X	-	X	-	X <sup>17)</sup>	X	-	X	-	X <sup>17)</sup>	X <sup>17)</sup>	X	-	X	-	-	-	-
Ethylene glycol base antifreeze, inhibited, open system	≤ 20	+110	X <sup>17)</sup>	X	-	X	-	-	-	-	-	-	-	X <sup>17)</sup>	X	-	X	-	-	-	-
	≤ 25	+110	X <sup>17)</sup>	X	-	X	-	-	-	-	-	-	-	X <sup>17)</sup>	X	-	X	-	-	-	-

<sup>17)</sup> ≤ 100 °C

Fluid handled			Design																		
Substance contained	Max. percentage	T <sub>Max.</sub>	V					VC					VS					LHS			
			Seal code																		
			[%]	[°C]	13	14	15	16	18	13	14	15	16	18	23	13	14	15	16	18	17
Ethylene glycol base antifreeze, inhibited, open system	≤ 30	+110	X <sup>17)</sup>	X	-	X	-	-	-	-	-	-	-	X <sup>17)</sup>	X	-	X	-	-	-	
	≤ 35	+110	X <sup>17)</sup>	X	-	X	-	-	-	-	-	-	-	X <sup>17)</sup>	X	-	X	-	-	-	
	≤ 40	+110	X <sup>17)</sup>	X	-	X	-	-	-	-	-	-	-	X <sup>17)</sup>	X	-	X	-	-	-	
	≤ 45	+110	X <sup>17)</sup>	X	-	X	-	-	-	-	-	-	-	X <sup>17)</sup>	X	-	X	-	-	-	
	≤ 50	+110	X <sup>17)</sup>	X	-	X	-	-	-	-	-	-	-	X <sup>17)</sup>	X	-	X	-	-	-	
Glycerine	≤ 40	+80	X	X	-	-	-	X	X	-	-	-	X	X	X	-	-	-	-	-	
Glycols (pure)	≤ 100	+100	-	-	-	-	-	-	-	-	-	-	-	-	-	-	-	-	-	-	
Diethylene glycol	≤ 100	+100	X	X	-	-	-	X	X	-	-	-	X	X	X	-	-	-	-	-	
Ethylene glycol	≤ 100	+100	X	X	-	-	-	X	X	-	-	-	X	X	X	-	-	-	-	-	
Potassium hydroxide	≤ 5	+40	-	-	X	-	-	-	X	-	-	-	-	-	X	-	-	-	-	-	
Potassium nitrate, acid-free	≤ 5	+30	-	-	X	-	-	-	X	-	-	-	-	-	X	-	-	-	-	-	
Potassium sulphate, acid-free	≤ 3	+20	-	X	-	-	-	-	X	-	-	-	-	-	X	-	-	-	-	-	
Copper sulphate	≤ 5	+80	-	-	X	-	-	-	-	-	-	-	-	-	X	-	-	-	-	-	
Magnesium sulphate	≤ 10	+80	-	X	-	-	-	-	-	-	-	-	-	-	X	-	-	-	X	-	
Milk	≤ 100	+60	X	X	-	-	-	-	-	-	-	-	-	X	X	-	-	-	-	-	
Lactic acid	≤ 40	+60	-	-	-	-	-	-	-	-	-	-	-	-	-	-	-	-	X	-	
Miscella <sup>18)</sup>	≤ 100	+40	-	-	-	-	-	-	-	-	-	-	-	-	-	-	-	-	-	-	
Sodium carbonate	≤ 6	+60	X	-	-	-	-	X	-	-	-	-	X	X	-	-	-	-	-	X	
Sodium hydroxide	≤ 5	+60	-	-	X	-	-	-	X	-	-	-	-	-	X	-	-	-	-	-	
Sodium nitrate, acid-free	≤ 10	+30	X	-	-	-	-	X	-	-	-	-	X	X	-	-	-	-	-	X	
Sodium nitrate, acid-free	≤ 10	+60	X	-	-	-	-	X	-	-	-	-	-	-	-	-	-	-	-	X	
Sodium sulphate, acid-free	≤ 5	+60	X	-	-	-	-	-	-	-	-	-	-	X	-	-	-	-	-	X	
Oil																					
▪ Peanut oil	≤ 100	+90	-	X	-	-	-	-	X	-	-	-	-	-	X	-	-	-	-	-	
▪ Peanut oil	≤ 100	+100	-	-	-	-	-	-	-	-	-	-	-	-	-	-	-	-	X	-	
▪ Hydraulic oil <sup>18)</sup>	≤ 100	+80	-	-	-	-	-	-	-	-	-	-	-	-	-	-	-	-	X	-	
▪ Linseed oil, ≤ 3 % H <sub>2</sub> SO <sub>4</sub>	≤ 100	+20	-	X	-	-	-	-	-	-	-	-	-	-	X	-	-	-	-	-	
▪ Linseed oil, ≤ 3 % H <sub>2</sub> SO <sub>4</sub>	≤ 100	+60	-	-	-	-	-	-	-	-	-	-	-	-	X	-	-	-	-	-	
▪ Linseed oil	≤ 100	+60	-	X	-	-	-	-	X	-	-	-	-	-	X	-	-	-	X	-	
▪ Corn oil	≤ 100	+100	-	X	-	-	-	-	X	-	-	-	-	-	X	-	-	-	X	-	
▪ Mineral oil <sup>18)</sup>	≤ 100	+80	-	-	-	-	-	-	-	-	-	-	-	-	-	-	-	-	X	-	
▪ Vegetable oil <sup>18)</sup>	≤ 100	+100	-	-	-	-	-	-	-	-	-	-	-	-	-	-	-	-	X	-	
▪ Rapeseed oil	≤ 100	+100	-	X	-	-	-	-	X	-	-	-	-	-	X	-	-	-	X	-	
▪ Salad oil	≤ 100	+100	-	-	-	-	-	-	-	-	-	-	-	-	-	-	-	-	X	-	
▪ Lubricating oil <sup>18)</sup>	≤ 100	+100	-	-	-	-	-	-	-	-	-	-	-	-	-	-	-	-	X	-	
▪ Silicone oil <sup>18)</sup>	≤ 100	+60	-	-	-	-	-	-	-	-	-	-	-	-	-	-	-	-	X	-	
▪ Soybean oil	≤ 100	+100	-	X	-	-	-	-	X	-	-	-	-	-	X	-	-	-	X	-	
▪ Turbine oil (no SDF oils) <sup>18)</sup>	≤ 100	+100	-	-	-	-	-	-	-	-	-	-	-	-	-	-	-	-	X	-	
▪ Oil/water mixtures	≤ 100	+100	-	-	-	-	-	-	-	-	-	-	-	-	-	-	-	-	X	-	
Paraffin <sup>18)</sup>	≤ 100	+100	-	-	-	-	-	-	-	-	-	-	-	-	-	-	-	-	X	-	
Kerosene	≤ 100	+80	-	X	-	-	-	-	-	-	-	-	-	-	X	-	-	-	X	-	
Polyethylene glycol <sup>18)</sup>	≤ 100	+80	-	-	-	-	-	-	-	-	-	-	-	-	-	-	-	-	X	X	
Polyglycol <sup>18)</sup>	≤ 100	+80	-	-	-	-	-	-	-	-	-	-	-	-	-	-	-	-	X	-	
Crude oil <sup>18)</sup>	≤ 100	+80	-	-	-	-	-	-	-	-	-	-	-	-	-	-	-	-	X	-	
Crude oil condensate <sup>18)</sup>	≤ 100	+80	-	-	-	-	-	-	-	-	-	-	-	-	-	-	-	-	X	-	
Juice (fruit and sugar juice)	≤ 100	+60	-	X	-	-	-	-	-	-	-	-	-	-	X	-	-	-	X	-	
Acid																					

<sup>18)</sup> Fluid details are required in this case.



Fluid handled			Design																	
Substance contained	Max. percentage	T <sub>Max.</sub>	V					VC					VS					LHS		
			Seal code																	
	[%]	[°C]	13	14	15	16	18	13	14	15	16	18	23	13	14	15	16	18	17	19
▪ Acetic acid	≤ 10	+60	X	-	-	-	-	-	-	-	-	-	-	X	-	-	-	-	-	-
▪ Acetic acid	≤ 5	+60	X	-	-	-	-	-	-	-	-	-	-	X	-	-	-	-	-	-
▪ Tannic acid	≤ 20	+80	-	X	-	-	-	-	-	-	-	-	-	-	X	-	-	-	-	-
▪ Maleic acid	≤ 10	+60	-	X	-	-	-	-	-	-	-	-	-	-	X	-	-	-	-	-
▪ Lactic acid	≤ 5	+60	-	X	-	-	-	-	-	-	-	-	-	-	X	-	-	-	-	-
▪ Lactic acid	≤ 40	+60	-	X	-	-	-	-	-	-	-	-	-	-	X	-	-	-	-	-
▪ Phosphoric acid	≤ 5	+20	-	X	-	-	-	-	-	-	-	-	-	-	X	-	-	-	-	-
▪ Sulphuric acid	≤ 5	+20	-	-	-	-	-	-	-	-	-	-	-	-	-	-	X	-	-	-
▪ Tartaric acid	≤ 8	+40	-	-	-	-	-	-	-	-	-	-	-	-	X	-	-	-	-	-
▪ Citric acid	≤ 25	+30	-	X	-	-	-	-	-	-	-	-	-	-	X	-	-	-	-	-
▪ Citric acid	≤ 10	+30	-	X	-	-	-	-	-	-	-	-	-	-	X	-	-	-	-	-
<b>Fuel</b>																				
▪ Diesel oil	≤ 100	+80	-	X	-	-	-	-	-	-	-	-	-	-	X	-	-	-	-	-
▪ Fuel oil	≤ 100	+80	-	X	-	-	-	-	-	-	-	-	-	-	X	-	-	-	-	-
▪ Kerosene (jet fuel)	≤ 100	+80	-	X	-	-	-	-	-	-	-	-	-	-	X	-	-	-	-	-
Trisodium phosphate	≤ 4	+80	-	-	X	-	-	-	X	-	-	-	-	-	-	X	-	-	-	-
<b>Water</b>																				
▪ Deionised water (fully desalinated)	≤ 100	+140	X	-	-	-	X <sup>19)</sup>	-	-	-	-	-	-	X	-	-	-	X <sup>19)</sup>	-	X
▪ Distilled water	≤ 100	+140	-	-	-	-	-	-	-	-	-	-	-	-	-	-	-	-	-	X <sup>20)</sup>
▪ Dealkalised water	≤ 100	+120	-	-	X	-	-	-	-	-	-	-	-	-	-	X	-	-	-	-
▪ Decarbonised water	≤ 100	+120	-	-	X	-	-	-	-	-	-	-	-	-	-	X	-	-	-	-
▪ Swimming pool water (no brine)	≤ 100	+100	-	-	-	-	-	-	-	-	-	-	-	-	-	-	-	-	X	-
▪ Permeate (osmosis)	≤ 100	+140	X	-	-	-	X <sup>19)</sup>	-	-	-	-	-	-	X	-	-	-	X <sup>19)</sup>	-	-
▪ Partly desalinated water	≤ 100	+120	-	-	X	-	-	-	-	-	-	-	-	-	-	X	-	-	-	-
▪ Fire-fighting water	≤ 100	+60	-	-	X	-	X	-	X	-	-	X	-	-	-	X	-	X	-	-
▪ Heating water in accordance with VDI 2035	≤ 100	+100	X	-	-	-	X	X	-	-	-	X	X	X	-	-	-	X	-	X <sup>20)</sup>
▪ Hot water treated in accordance with VdTÜV 1466	≤ 100	+140	X <sup>17)</sup>	-	-	-	X <sup>19)</sup>	X <sup>17)</sup>	-	-	-	X <sup>19)</sup>	X <sup>17)</sup>	X <sup>17)</sup>	-	-	-	X <sup>19)</sup>	-	X <sup>20)</sup>
▪ Boiler feed water to VdTÜV 1466	≤ 100	+140	X <sup>17)</sup>	-	-	-	X <sup>19)</sup>	X <sup>17)</sup>	-	-	-	X <sup>19)</sup>	X <sup>17)</sup>	X <sup>17)</sup>	-	-	-	X <sup>19)</sup>	-	X <sup>20)</sup>
▪ Condensate treated in acc. with VdTÜV 1466	≤ 100	+140	X <sup>17)</sup>	-	-	-	X <sup>19)</sup>	X <sup>17)</sup>	-	-	-	X <sup>19)</sup>	X <sup>17)</sup>	X <sup>17)</sup>	-	-	-	X <sup>19)</sup>	-	X <sup>20)</sup>
▪ Vapour condensate (brewery)	≤ 100	+140	X <sup>17)</sup>	-	-	-	X <sup>19)</sup>	X <sup>17)</sup>	-	-	-	X <sup>19)</sup>	X <sup>17)</sup>	X <sup>17)</sup>	-	-	-	X <sup>19)</sup>	-	-
▪ Cooling water	≤ 100	+100	-	-	-	X	-	-	-	-	X	-	-	-	-	-	X	-	-	-
▪ Tap water	≤ 100	+60	X	-	-	-	-	X	-	-	-	-	-	X	-	-	-	-	-	-
▪ Brewing water	≤ 100	+60	X	-	-	-	-	X	-	-	-	-	-	X	-	-	-	-	-	-
▪ Ice water (brewery)	≤ 100	+60	X	-	-	-	-	X	-	-	-	-	-	X	-	-	-	-	-	-
▪ Drinking water / tap water	≤ 100	+60	X	-	-	-	-	X	-	-	-	-	-	X	-	-	-	-	-	X
▪ Hot water (brewery)	≤ 100	+60	X	-	-	-	-	X	-	-	-	-	-	X	-	-	-	-	-	-

<sup>19</sup> ≤ 120 °C, depending on the pressure classes

<sup>20</sup> ≤ 120 °C

Fluid handled			Design																	
Substance contained	Max. percentage	T <sub>Max.</sub>	V					VC					VS					LHS		
			Seal code																	
	[%]	[°C]	13	14	15	16	18	13	14	15	16	18	23	13	14	15	16	18	17	19
▪ Clean water	≤ 100	+60	X	X	X	X	X	X	X	X	X	X	X	X	X	X	X	X	-	-
▪ Brackish water	≤ 100	+15	-	-	-	-	-	-	-	-	-	-	-	-	-	-	X	-	-	-
▪ Seawater	≤ 100	+15	-	-	-	-	-	-	-	-	-	-	-	-	-	-	X	-	-	-
▪ Raw water	≤ 100	+60	-	-	X	-	-	-	-	X	-	-	-	-	-	X	-	-	-	-
▪ Grey water, slightly contaminated water	≤ 100	+60	-	-	X	-	-	-	-	X	-	-	-	-	-	X	-	-	-	-
▪ River water	≤ 100	+60	-	-	X	-	-	-	-	X	-	-	-	-	-	X	-	-	-	-
▪ Lake water	≤ 100	+60	-	-	X	-	-	-	-	X	-	-	-	-	-	X	-	-	-	-
▪ Dam water	≤ 100	+60	-	-	X	-	-	-	-	X	-	-	-	-	-	X	-	-	-	-
▪ Surface water	≤ 100	+60	-	-	X	-	-	-	-	X	-	-	-	-	-	X	-	-	-	-
▪ Fresh water	≤ 100	+60	-	X	-	-	-	-	X	-	-	-	-	-	X	-	-	-	-	-
▪ Barrier water	≤ 100	+70	-	-	-	X	-	-	-	-	X	-	-	-	-	-	X	-	-	-
▪ Rinsing water	≤ 100	+70	-	-	-	X	-	-	-	-	X	-	-	-	-	-	X	-	-	-
▪ Rainwater, with strainer	≥ 20	+60	-	-	-	X	-	-	-	-	X	-	-	-	-	-	X	-	-	-
▪ Water/glycol mixture	≤ 100	+100	-	-	-	-	-	-	-	-	-	-	-	-	-	-	-	-	-	X

**Shaft seal**
**Table 11:** Available mechanical seals

Seal code	Mechanical seal					T		Pressure [bar]	Certification
	Type	Material	Design			Min. [°C]	Max. [°C]		
			F	E	C				
11	M12G-G60	BQ1EGG	X	X	X	-20	+100	10	-
12	M12G-G60	BQ1VGG	X	X	X	-20	+120	10	-
13	RMG12-G606	Q1BEGG	X	X	X	-20	+100	25	WRAS
14	RMG12-G606	Q1BVGG	X	X	X	-20	+120	25	-
15	RMG12-G606	U3U3X4GG	X	X	X	-20	+120 <sup>21)</sup>	25	-
16	RMG12-G606	U3U3VGG	X	X	X	-20	+120 <sup>21)</sup>	25	-
17	M37GN2/16-00-R	U3BVGG <sup>22)</sup>	X	-	-	-20	+120 <sup>23)</sup>	40	-
18	RMG12-G606	U3BEGG	X	X	X	-20	+120 <sup>21)</sup>	25	-
19	M37GN2/16-00-R	U3BEGG <sup>22)</sup>	X	-	-	-20	+120 <sup>23)</sup>	40	-
20	H7N	Q1AEGG <sup>24)</sup>	-	-	X	-20	+120 <sup>25)</sup>	40	-
21	H7N	Q1AVGG <sup>24)</sup>	-	-	X	-20	+120 <sup>25)</sup>	40	-
22	H7N	Q1AX4GG	-	-	X	-20	+120 <sup>25)</sup>	40	-
23	RMG12-G606	Q1BEGG	X	X	X	-20	+100	25	-
24	MG12-G60	Q1Q1VGG	X	X	X	-20	+120	10	-
28	MG12-G60	Q1Q1X4GG	X	X	X	-20	+120	10	-
29	MG12-G60	Q1Q1EGG	X	X	X	-20	+100	10	-
35	RMG12-G6	eCarb-B eSic-Q7EGG	-	-	X	-20	+120	25	WRAS
36	MG12-G6	eCarb-B eSic-Q7VGG	-	-	X	-20	+120	25	-
37	RMG12-G606	U3AVGG	-	-	X	-20	+120 <sup>21)</sup>	25	-
40	4MC	Q1Q1EGG <sup>26)</sup>	-	-	X	-20	+120	40	-

<sup>21</sup> Temperatures up to +140 °C if the pressure does not exceed 16 bar

<sup>22</sup> For Movitec LHS only

<sup>23</sup> If the pressure does not exceed 25 bar. Temperatures up to +80 °C if the pressure does not exceed 40 bar

<sup>24</sup> Movitec 90B

<sup>25</sup> Temperatures up to +140 °C if the pressure does not exceed 25 bar

<sup>26</sup> Movitec 2B, 4B, 6B, 10B, 15B/C, 25B, 40B, 60B, 125B

Seal code	Type	Mechanical seal				T		Pressure [bar]	Certification
		Material	Design			Min.	Max.		
			F	E	C	[°C]	[°C]		
41	4MC	Q1AEGG <sup>26)</sup>	-	-	X	-20	+120	40	-
42	4MC	Q1Q1VGG <sup>26)</sup>	-	-	X	-20	+120	40	-
43	4MC	Q1AVGG <sup>26)</sup>	-	-	X	-20	+120	40	-

Table 12: Key to mechanical seal materials

Description	Code to EN 12756	Seal face materials / secondary seals
Primary ring	B	Hard carbon, resin-impregnated
	U3	Tungsten carbide (CrNiMo binder)
	Q1	Silicon carbide, sintered without pressure
	eCarb-B	Carbon graphite, resin-impregnated
Mating ring	A	Carbon graphite, antimony-impregnated
	B	Hard carbon, resin-impregnated
	U3	Tungsten carbide (CrNiMo binder)
	Q1	Silicon carbide, sintered without pressure
	eSic-Q7	Silicon carbide
Elastomer	E	EPDM (ethylene propylene rubber)
	V	FPM (fluoroelastomer)
	X4	HNBR
Spring	G	CrNiMo steel
Other metal parts	G	CrNiMo steel

**Technical data**
**Motors**

- Efficiency class IE3 to IEC 60034-30 (for three-phase motors  $\geq 0.75$  kW)







**Table 13: Technical data of the motors**

$P_N$	$U_N$	$I_A$	$I_A/I_N$	$\cos \varphi$	Tolerance $V_N$	$n$	$\eta$	$L_p$	Cable gland	Maximum frequency of starts
[kW]	[V]	[A]			[%]	rpm	[%]	[dB]		[/h]
<b>Movitec 2B, 4B, 6B, 25B, 40B, 60B, 90B, 125B</b>										
0,37	1 x 230	2,6	3,7	0,92	+/-10	2750	67,00	58	1x M18x1,5	20
0,55	1 x 230	3,69	3,9	0,92	+/-10	2760	70,00	56	1x M18x1,5	20
0,75	1 x 230	5	3,9	0,92	+/-10	2780	70,00	56	1x M20x1,5	20
1,1	1 x 230	6,68	4,3	0,95	+/-10	2790	75,00	58	1x M20x1,5	20
1,5	1 x 230	8,99	4,8	0,95	+/-10	2800	76,00	58	1x M20x1,5	20
2,2	1 x 230	13,04	4,8	0,95	+/-10	2800	77,00	58	1x M20x1,5	20
0,37	230/400	1,64/0,94	4,6	0,78	+/-10	2750	74,20	58	1x M20x1,5	20
0,55	230/400	2,31/1,33	5,2	0,75	+/-10	2790	77,60	58	1x M20x1,5	20
0,75	230/400	2,92/1,68	6,8	0,8	+/-10	2855	80,50	60	2x M20x1,5	25
1,1	230/400	4,17/2,4	7	0,8	+/-10	2855	82,70	60	2x M25x1,5	25
1,5	230/400	5,08/2,92	7,7	0,88	+/-10	2900	84,20	63	2x M25x1,5	25
2,2	230/400	7,22/4,15	7,7	0,89	+/-10	2900	86,00	63	2x M25x1,5	25
3	230/400	9,71/5,59	8,8	0,89	+/-10	2910	87,10	63	2x M25x1,5	20
3	400/690	5,59/3,24	8,8	0,89	+/-10	2910	87,10	63	2x M25x1,5	20
4	230/400	13,0/7,45	8,5	0,88	+/-10	2910	88,10	63	2x M25x1,5	20
4	400/690	7,45/4,32	8,5	0,88	+/-10	2910	88,10	63	2x M25x1,5	20
5,5	230/400	17,4/10,0	8,8	0,89	+/-10	2925	89,20	68	2x M32x1,5	20
5,5	400/690	10,0/5,80	8,8	0,89	+/-10	2925	89,20	68	2x M32x1,5	20
7,5	230/400	23,2/13,4	8,8	0,9	+/-10	2925	89,80	68	2x M32x1,5	20
7,5	400/690	13,4/7,74	8,8	0,9	+/-10	2925	89,80	68	2x M32x1,5	20
11	230/400	33,6/19,3	8	0,9	+/-10	2940	91,20	68	2x M32x1,5	15
11	400/690	19,3/11,2	8	0,9	+/-10	2940	91,20	68	2x M32x1,5	15
15	230/400	45,5/26,2	8	0,9	+/-10	2940	91,90	68	2x M32x1,5	15
15	400/690	26,2/15,2	8	0,9	+/-10	2940	91,90	68	2x M32x1,5	15
18,5	230/400	55,2/31,8	8	0,91	+/-10	2945	92,40	68	2x M32x1,5	15
18,5	400/690	31,8/18,4	8	0,91	+/-10	2945	92,40	68	2x M32x1,5	15
22	230/400	65,5/37,6	8,5	0,91	+/-10	2955	92,70	70	2x M32x1,5	15
22	400/690	37,6/21,8	8,5	0,91	+/-10	2955	92,70	70	2x M32x1,5	15
30	230/400	89,7/51,6	8,5	0,9	+/-10	2965	93,30	73	2x M32x1,5	15
30	400/690	51,6/29,9	8,5	0,9	+/-10	2965	93,30	73	2x M50x1,5	15
37	230/400	110/63,3	8,5	0,9	+/-10	2965	93,70	73	2x M50x1,5	15
37	400/690	63,3/36,7	8,5	0,9	+/-10	2965	93,70	73	2x M50x1,5	15
45	230/400	134/76,8	8,5	0,9	+/-10	2970	94,00	75	2x M50x1,5	15
45	400/690	76,8/44,5	8,5	0,9	+/-10	2970	94,00	75	2x M50x1,5	15
0,55	230/400	2,34/1,34	5,3	0,73	+/-10	1425	80,70	57	1x M20x1,5	20
0,75	230/400	3,13/1,8	6,5	0,73	+/-10	1425	82,50	57	1x M20x1,5	20
1,1	230/400	4,21/2,42	6,5	0,78	+/-10	1440	84,40	58	1x M20x1,5	20
1,5	230/400	5,59/3,21	7	0,79	+/-10	1440	85,30	58	1x M25x1,5	20
2,2	230/400	7,86/4,52	7,5	0,81	+/-10	1445	86,70	59	2x M25x1,5	20
3	230/400	10,6/6,10	7,5	0,81	+/-10	1445	87,70	59	2x M25x1,5	20
3	400/690	6,10/3,53	7,5	0,81	+/-10	1445	87,70	59	2x M25x1,5	20
4	230/400	14,0/8,05	8,5	0,81	+/-10	1450	88,50	60	2x M25x1,5	20
4	400/690	8,05/4,66	8,5	0,81	+/-10	1450	88,60	60	2x M25x1,5	20
5,5	230/400	19,0/10,9	8,5	0,81	+/-10	1460	89,90	60	2x M32x1,5	20
5,5	400/690	10,9/6,34	8,5	0,81	+/-10	1460	89,60	60	2x M32x1,5	20
7,5	230/400	25,4/14,6	8,5	0,82	+/-10	1460	90,40	60	2x M32x1,5	20
7,5	400/690	14,6/8,47	8,5	0,82	+/-10	1460	90,40	60	2x M32x1,5	20
<b>Movitec 10B, 15C</b>										
0,75	1 x 230	5	3,9	0,92	+/-10	2780	70,00	56	1x M20x1,5	20
1,1	1 x 230	6,68	4,3	0,95	+/-10	2790	75,00	58	1x M20x1,5	20

$P_N$	$U_N$	$I_A$	$I_A/I_N$	$\cos \varphi$	Tolerance $V_N$	$n$	$\eta$	$L_p$	Cable gland	Maximum frequency of starts
[kW]	[V]	[A]			[%]	rpm	[%]	[dB]		[/h]
1,5	230/400	5,3/3,0	7,3	0,85	+/- 10	2925	84,2	55	1x M20x1,5	50
2,2	230/400	7,5/4,3	8,0	0,86	+/- 10	2910	85,9	55	1x M20x1,5	30
3	230/400	10,2/5,8	9,3	0,85	+/- 10	2920	87,1	57	2x M20x1,5	30
3	400/690	5,8/3,3	9,3	0,85	+/- 10	2920	87,1	57	2x M20x1,5	30
4	230/400	12,8/7,4	8,4	0,89	+/- 10	2930	88,1	58	2x M20x1,5	30
4	400/690	7,4/4,3	8,4	0,89	+/- 10	2930	88,1	58	2x M20x1,5	30
5,5	230/400	17,3/10	8,8	0,89	+/- 10	2940	89,2	63	2x M25x1,5	20
5,5	400/690	10/5,8	8,8	0,89	+/- 10	2940	89,2	63	2x M25x1,5	20
7,5	230/400	23/13,3	9,2	0,89	+/- 10	2940	90,1	63	2x M25x1,6	20
7,5	400/690	13,3/7,7	9,2	0,89	+/- 10	2940	90,1	63	2x M25x1,5	20
11	230/400	33,4/19,3	7,3	0,9	+/- 10	2945	91,2	69	2x M32x1,5	15
11	400/690	19,3/11,2	7,3	0,9	+/- 10	2945	91,2	69	2x M32x1,5	15
15	230/400	45,4/26,2	7,4	0,9	+/- 10	2945	91,9	69	2x M32x1,5	15
15	400/690	26,2/15,2	7,4	0,9	+/- 10	2945	91,9	69	2x M32x1,5	15

### Types of connection

Table 14: Overview of available connection types

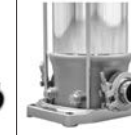
Description	Design							
	V / VS	VF	VSF <sup>27)</sup>	VCF	LHS	VE / VME <sup>27)</sup>	VV / VMV / VSV	VT / VST / VMT <sup>27)</sup>
Connection type	Oval flange / Internal thread	Round flange				External thread	Victaulic coupling	Tri-Clamp fitting
								
Standard	ISO 228-1	EN 1092-1/EN 1092-2 ASME B 16.1 JIS			EN1092-2	ISO 228-1	-	DIN 32676
Material	1.4308 <sup>28)</sup> / 1.4408 <sup>29)</sup>	EN-GJS-400-15	1.4308	EN-GJL-250 <sup>30)</sup> / EN-GJS-400-15 <sup>31)</sup>	1.4408	EN-GJS-400-15	1.4408	1.4408
Maximum pressure class	PN 16	PN 40			PN 40	PN 16	PN 40	PN 40

<sup>27</sup> The stainless steel baseplate shown is available as an option.

<sup>28</sup> For Movitec V

<sup>29</sup> For Movitec VS

<sup>30</sup> Movitec 2B, 4B, 6B, 10B, 15B/C, 25B, 40B, 60B, 125B

<sup>31</sup> Movitec 90B

Selection charts  
 Movitec, n = 2900 rpm

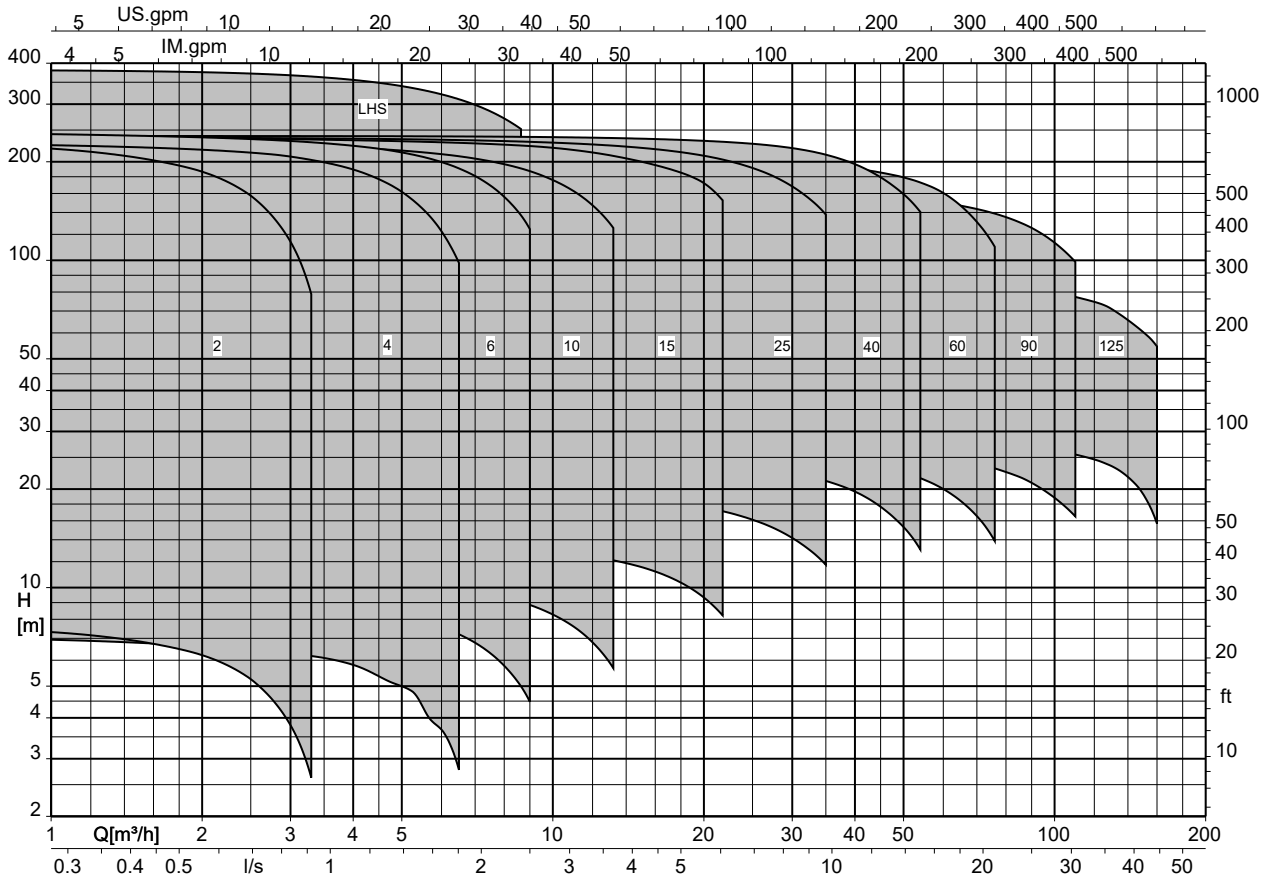

Movitec, n = 1450 rpm

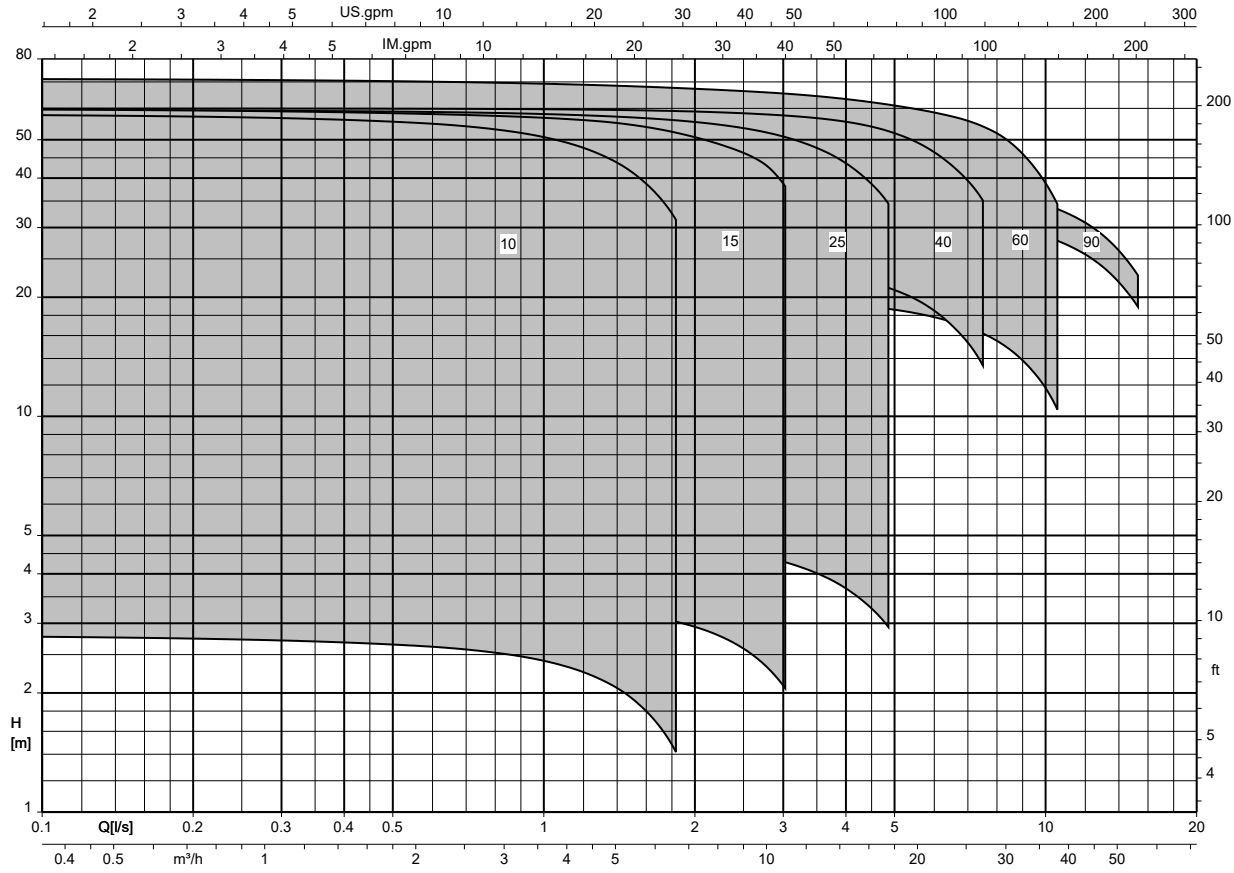

### Characteristic curves

The characteristic curves are based on the following principles:

- Tolerances to ISO 9906:2012 Grade 3B

The characteristic curves were measured under the following conditions:

- Motor used:
  - Standardised KSB motor with integrated frequency inverter
- Fluid properties:
  - Deaerated water
  - Fluid temperature: +20 °C
  - Density: 1.0 kg/dm<sup>3</sup>
  - Kinematic viscosity: 1 mm<sup>2</sup>/s



n = 2900 rpm

Movitec 2B, n = 2900 rpm

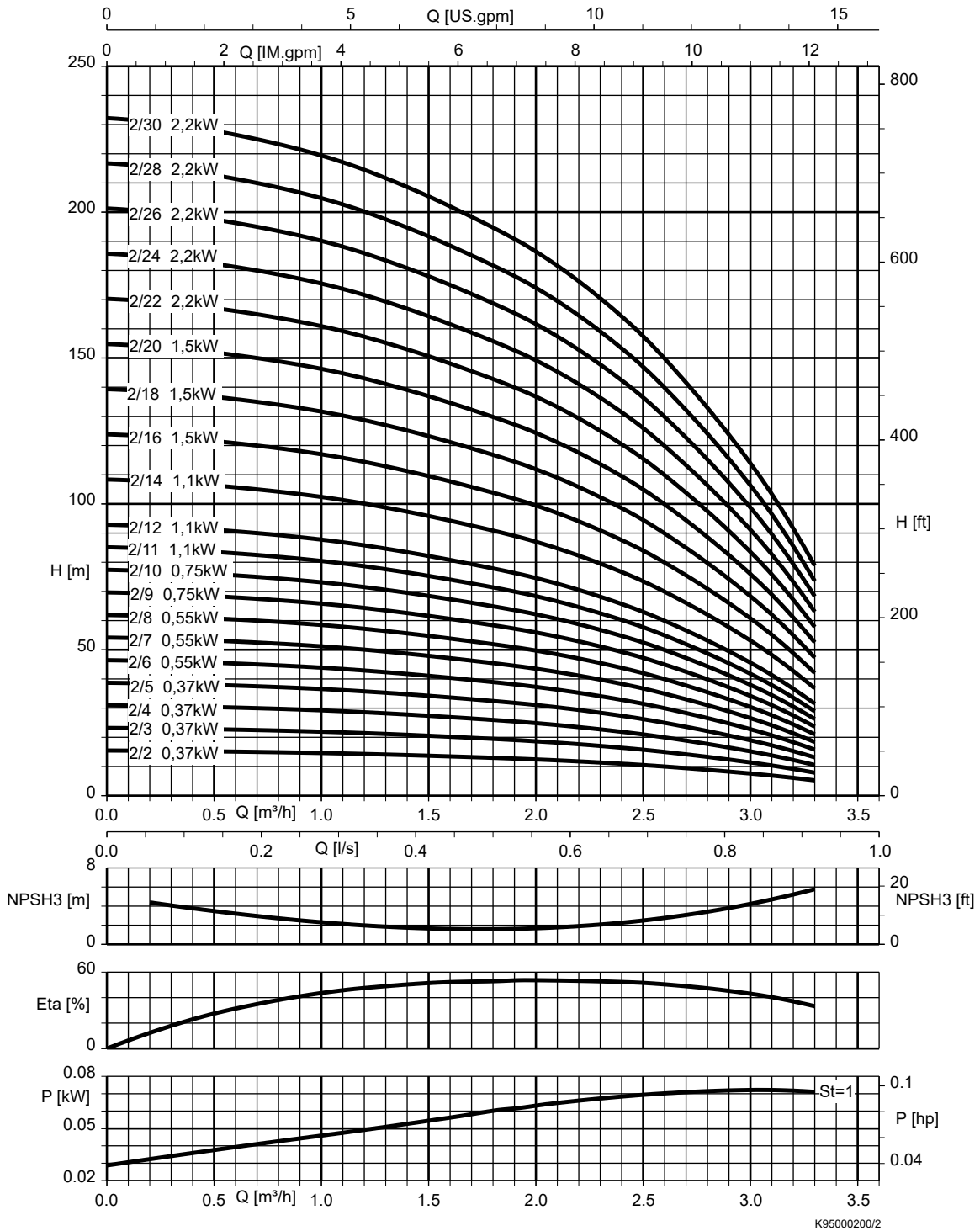

St = 1 | P per stage

Movitec 25B, n = 2900 rpm

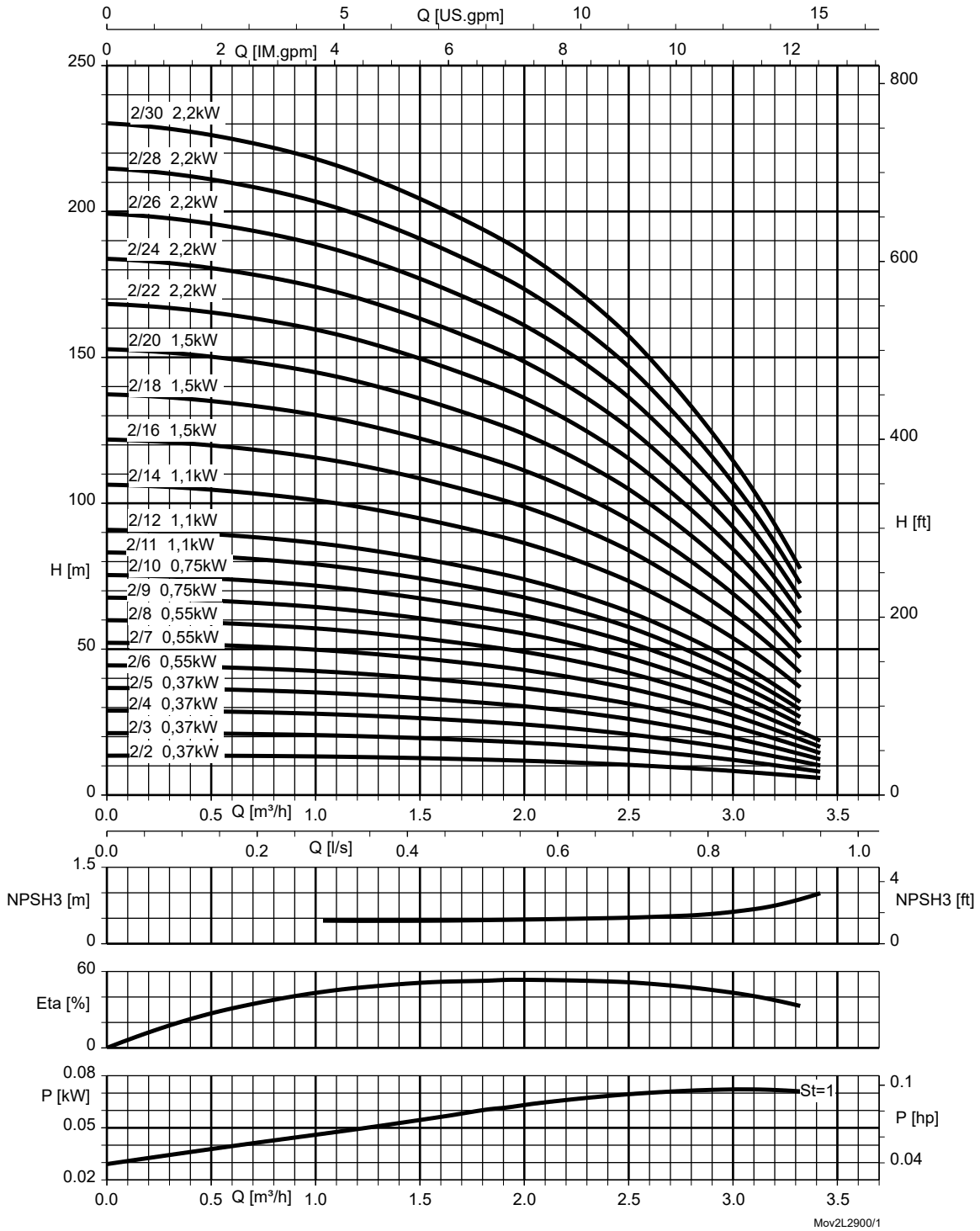

St = 1 | P per stage

Movitec 4B, n = 2900 rpm

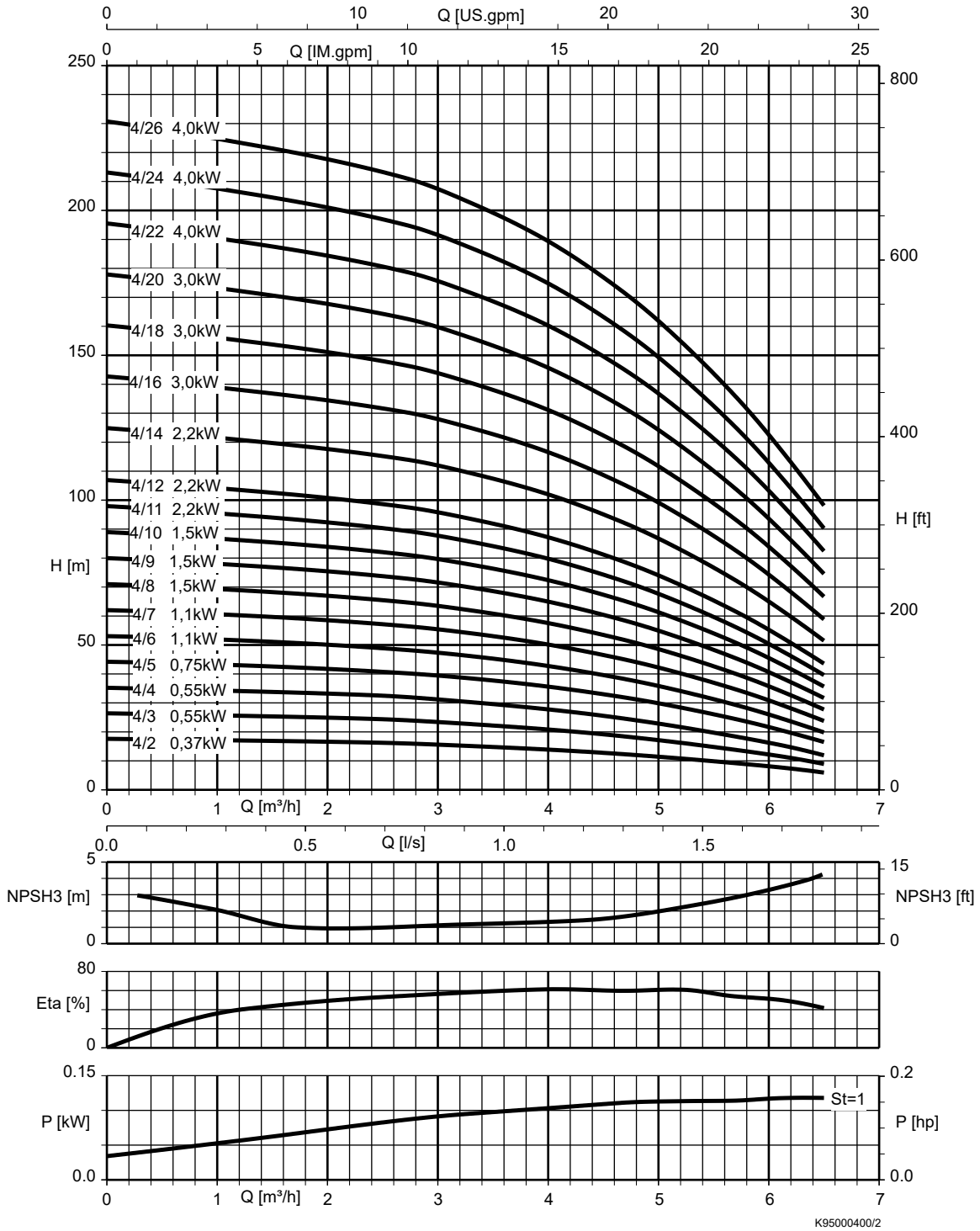

St = 1 | P per stage

Movitec 4LB, n = 2900 rpm

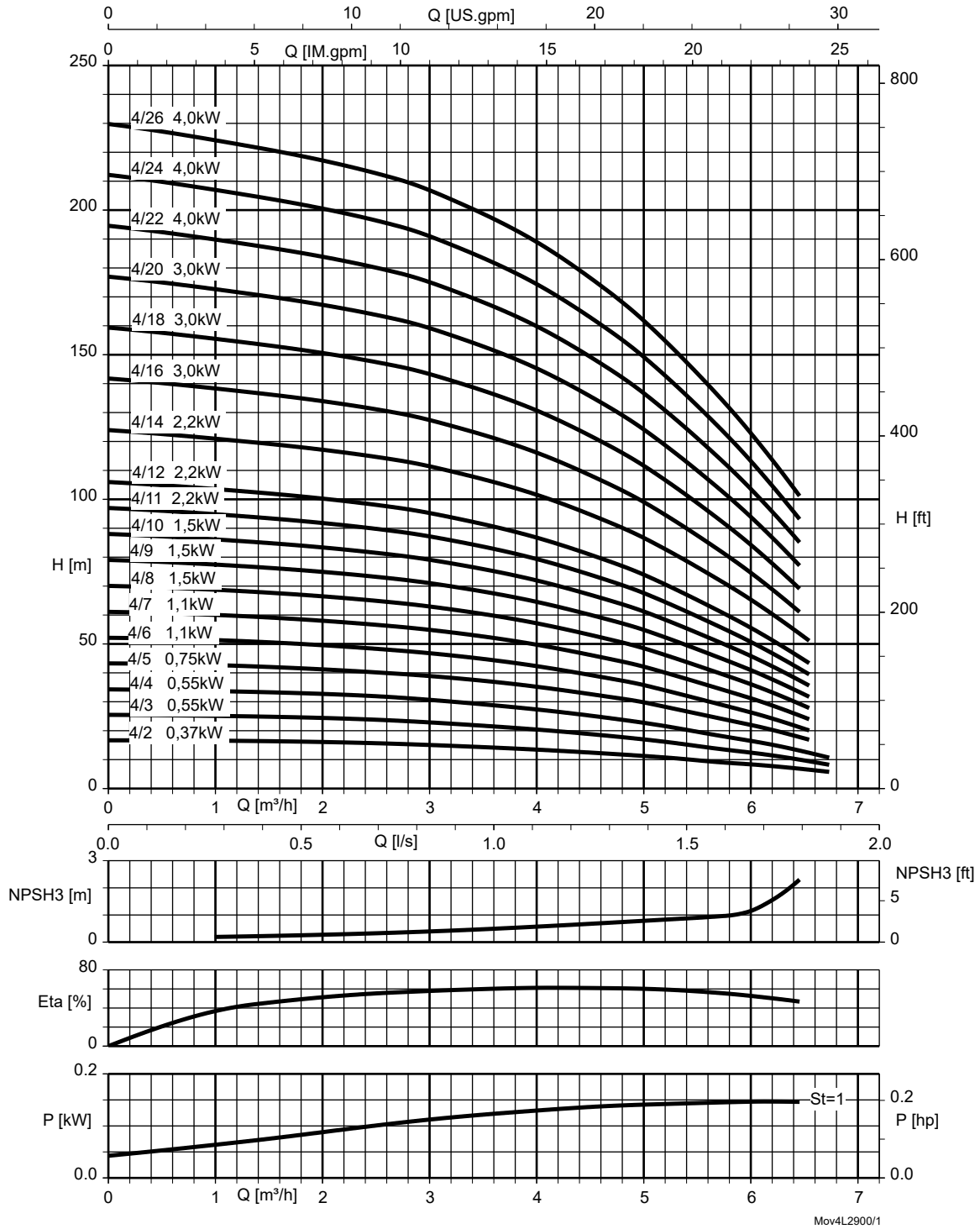

St = 1 | P per stage

Movitec 6B, n = 2900 rpm

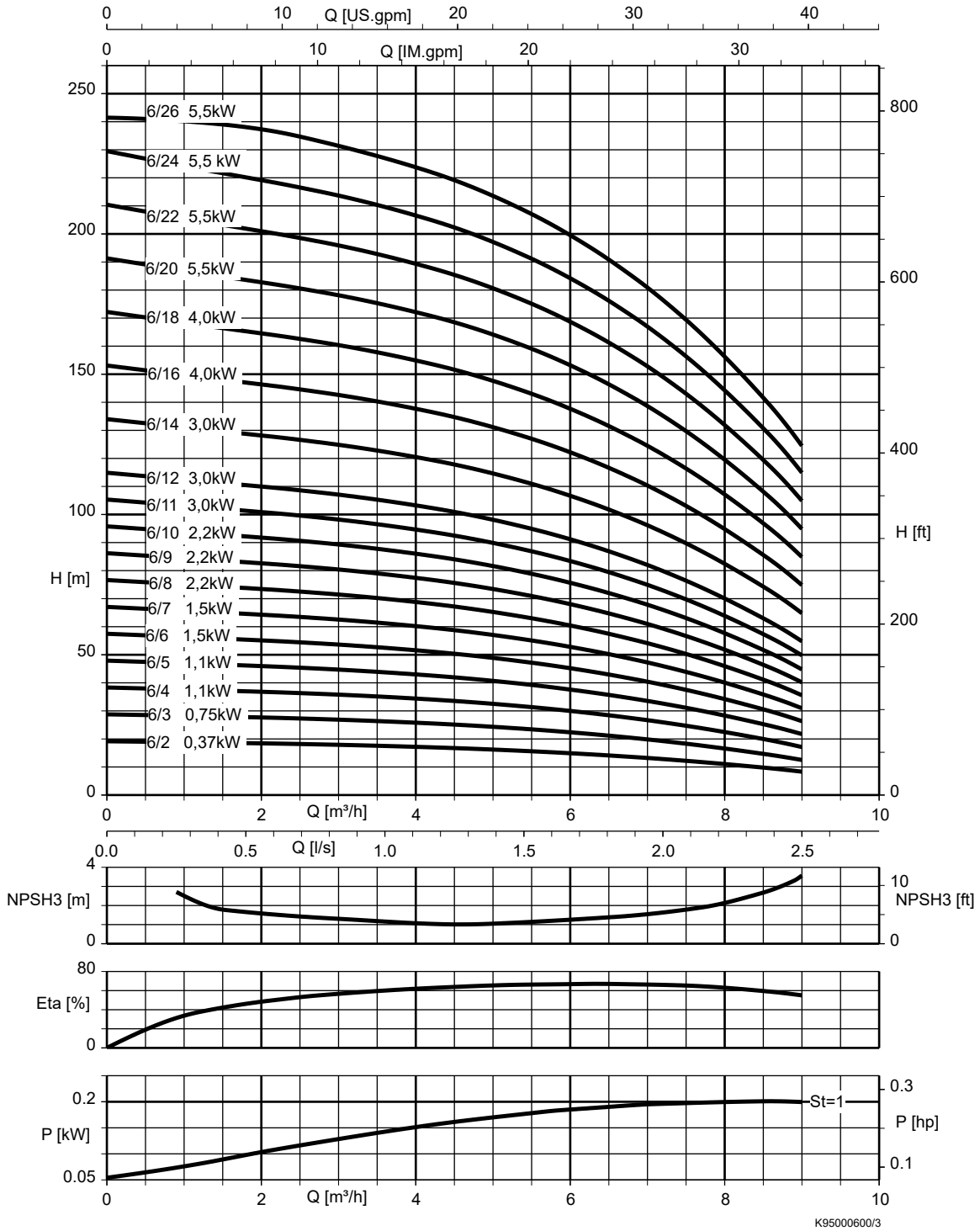

St = 1 | P per stage

Movitec 6LB, n = 2900 rpm

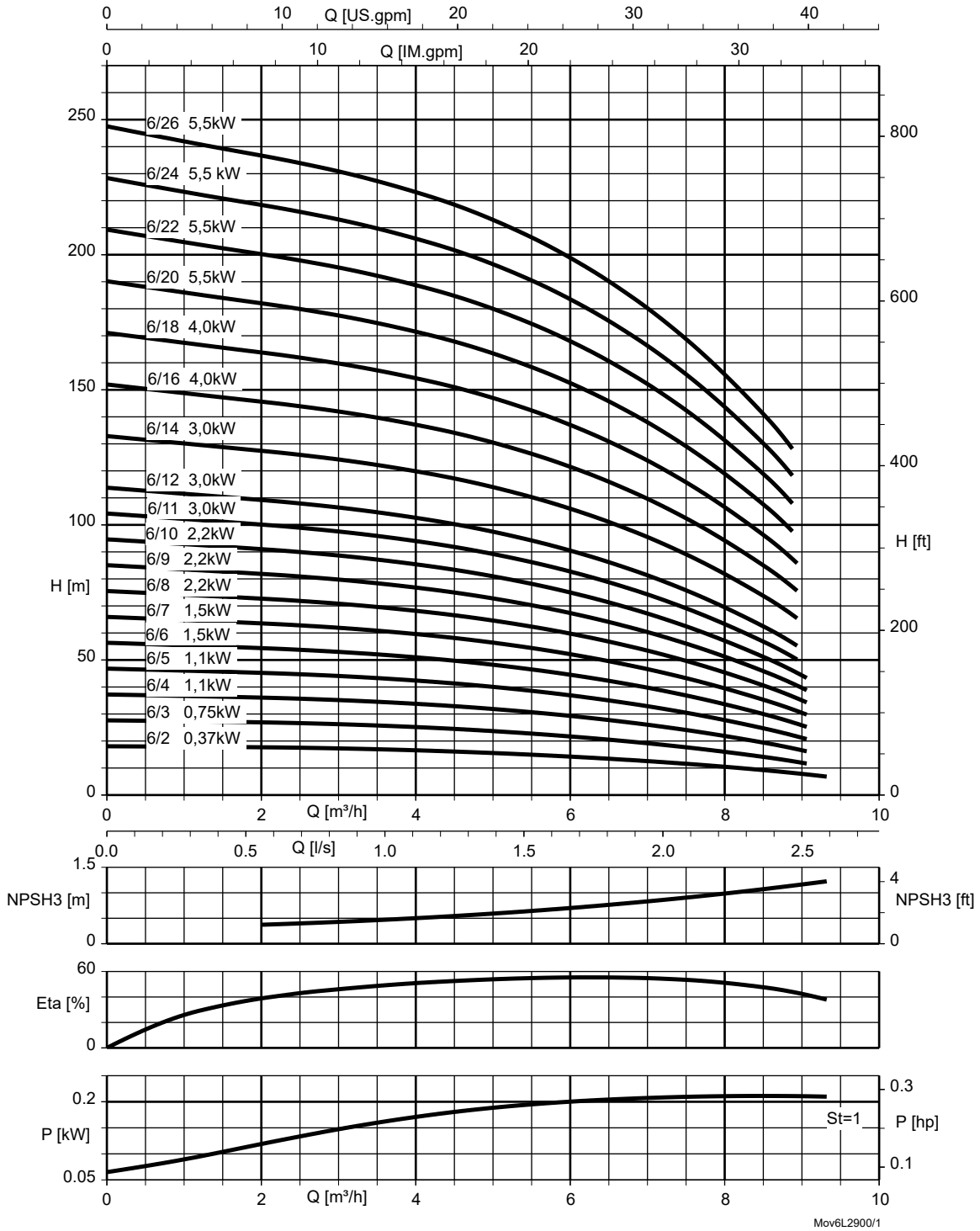

St = 1 | P per stage

Movitec 10B, n = 2900 rpm

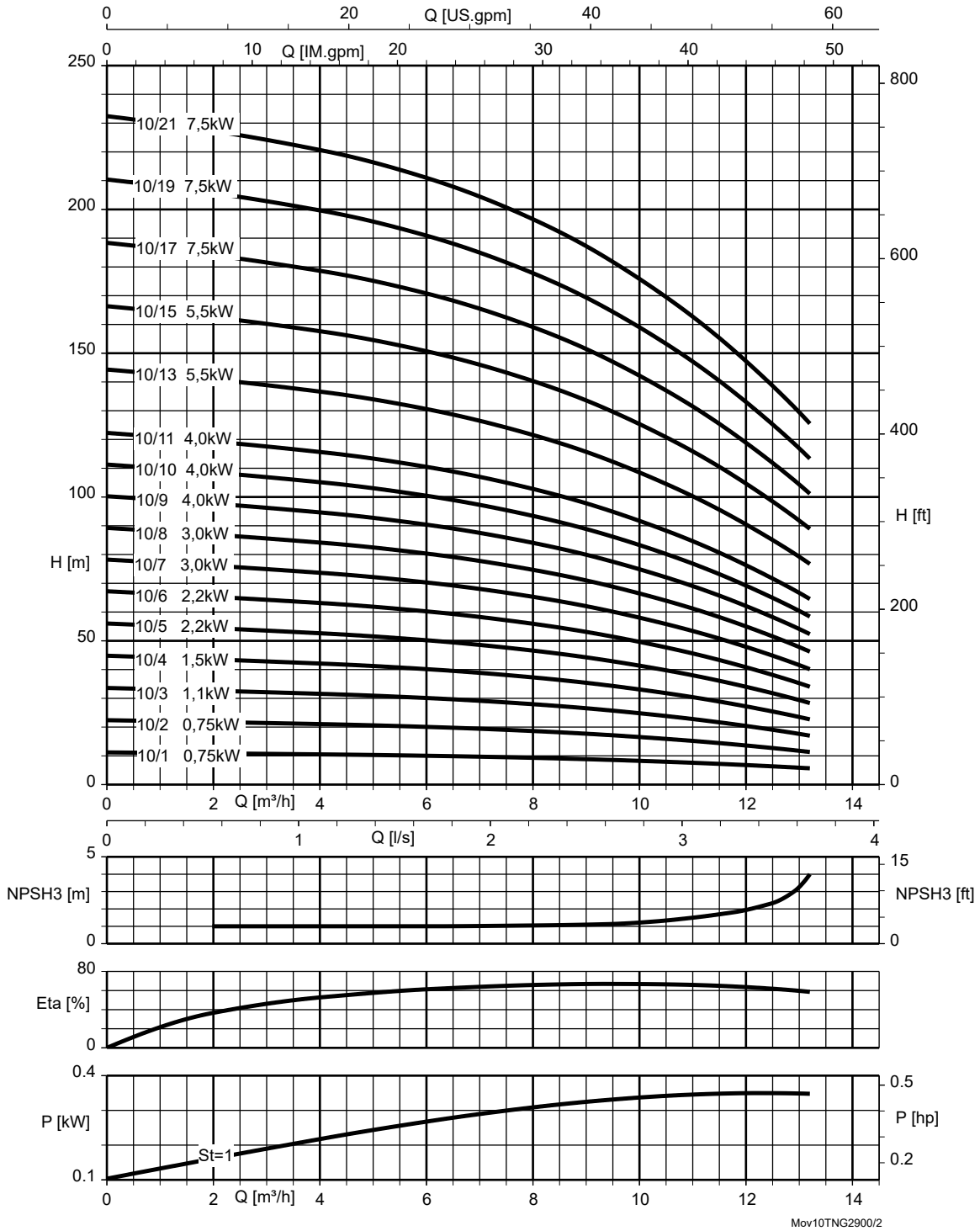

St = 1 | P per stage

Movitec 10LB, n = 2900 rpm

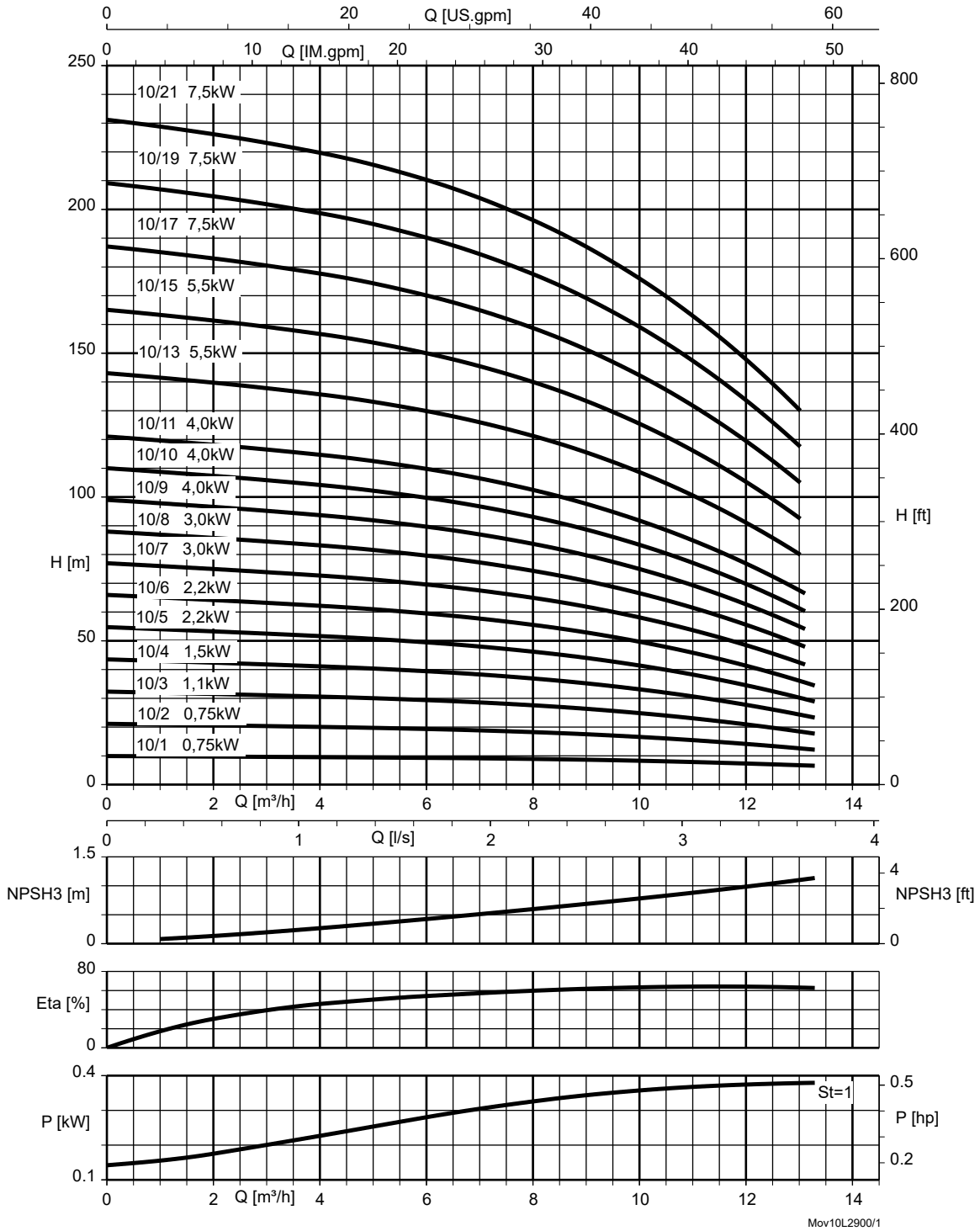

St = 1 | P per stage



Movitec 15C, n = 2900 rpm

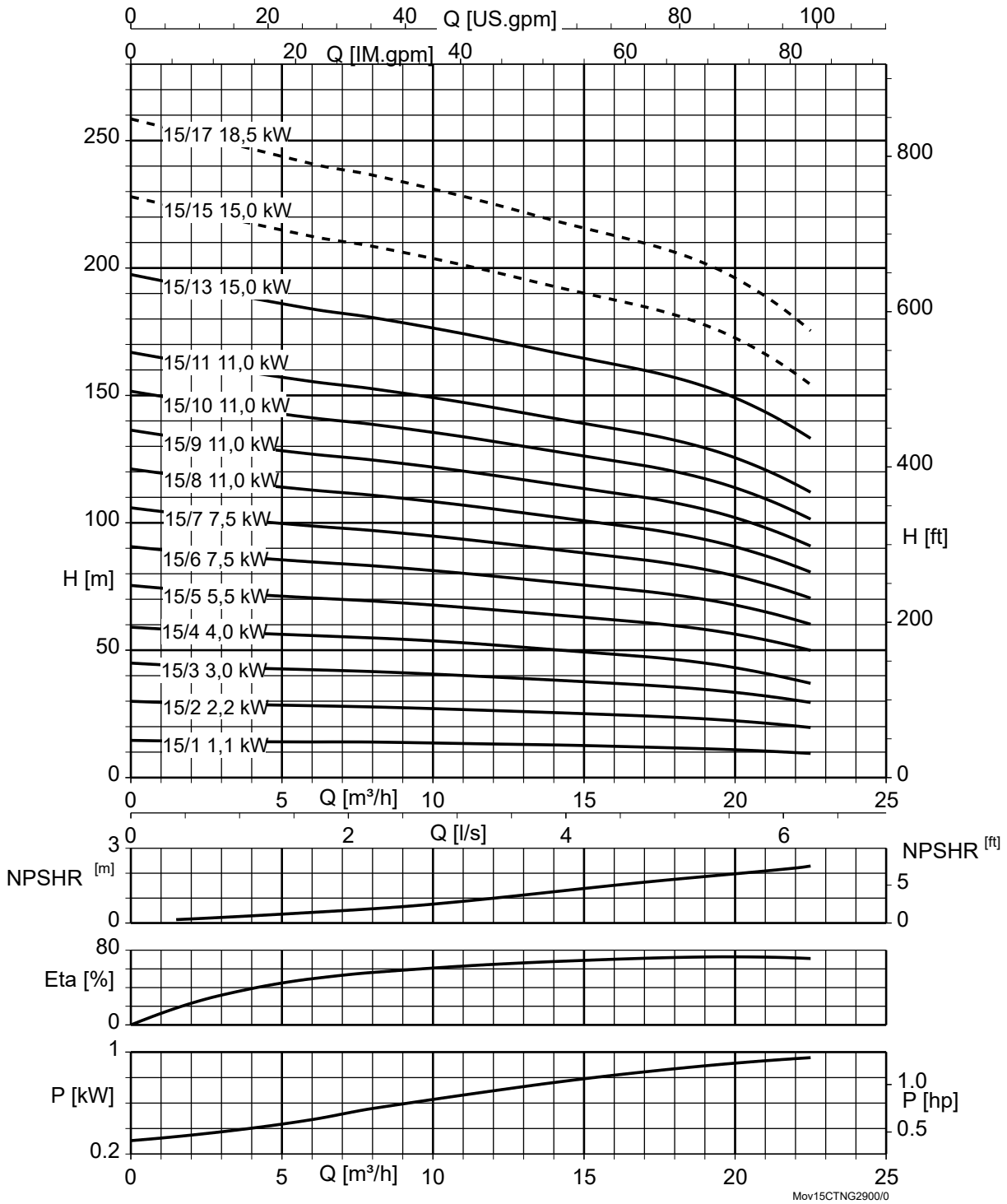

St = 1 | P per stage

Movitec 15LC, n = 2900 rpm

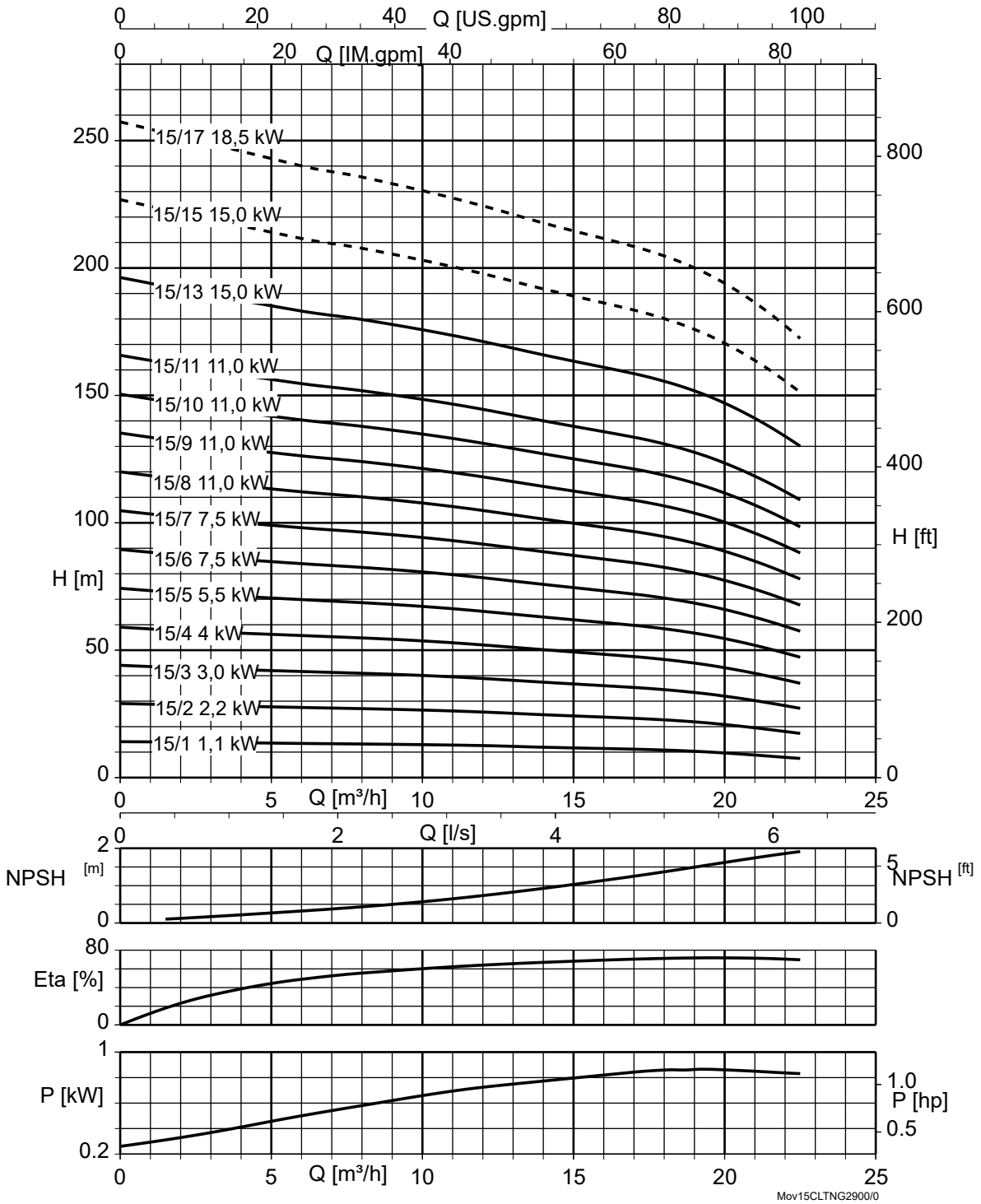

St = 1 | P per stage

Movitec 25B, n = 2900 rpm

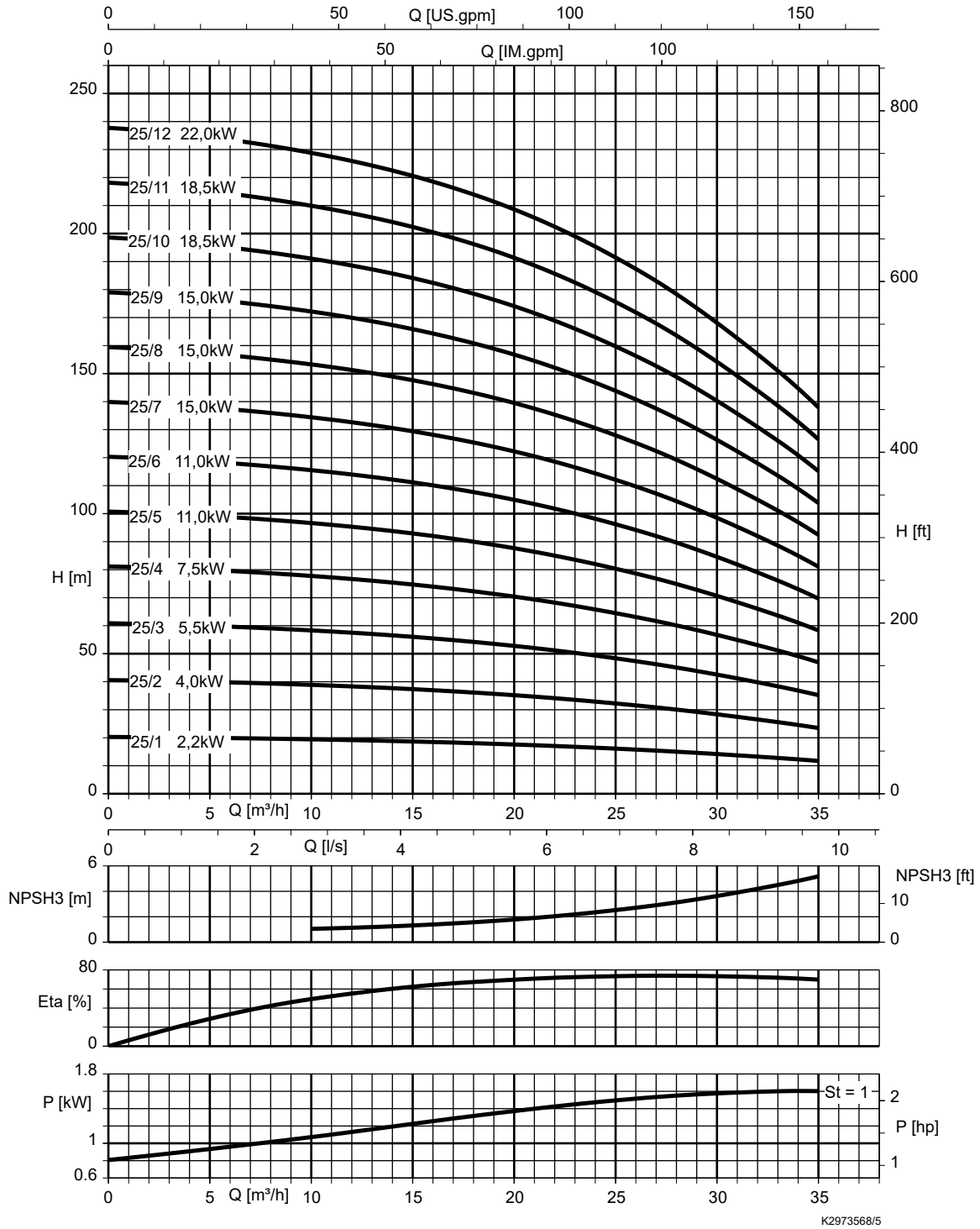

K2973568/5

St = 1 | P per stage

Movitec 40B, n = 2900 rpm

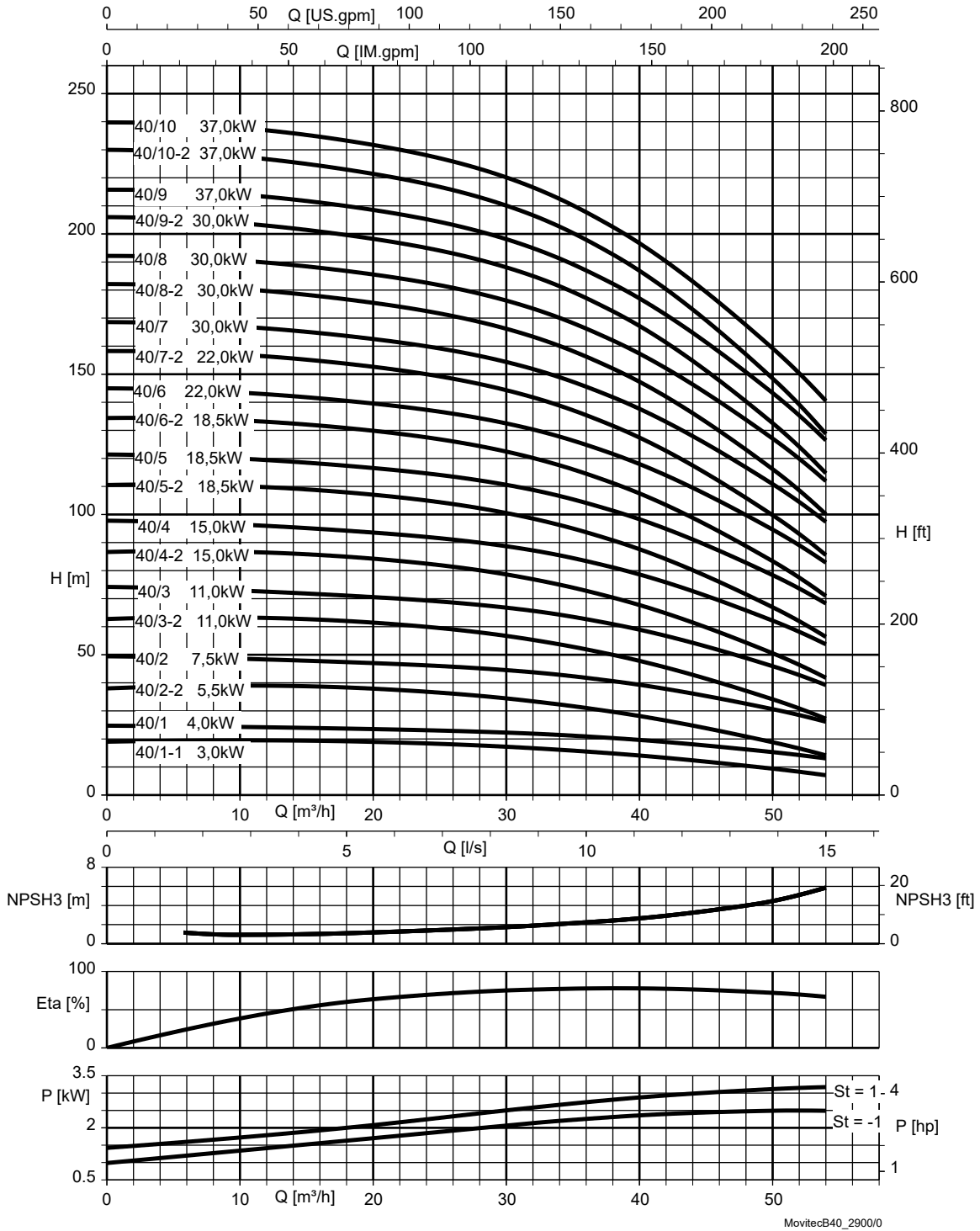

St = 1	P per stage	St = -1	P per stage with a smaller impeller
--------	-------------	---------	-------------------------------------

Movitec 60B, n = 2900 rpm

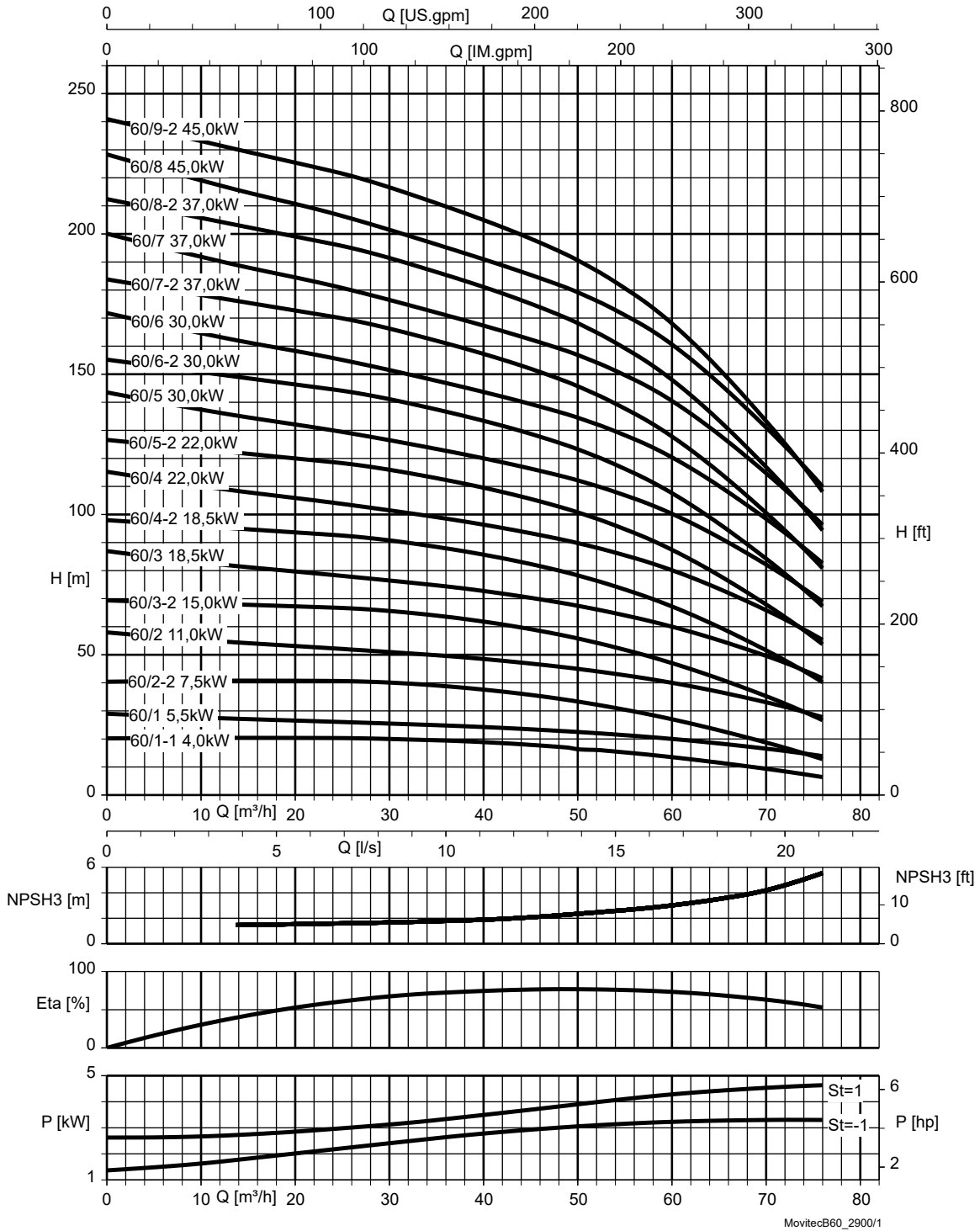

St = 1	P per stage	St = -1	P per stage with a smaller impeller
--------	-------------	---------	-------------------------------------

Movitec 90B; n = 2900 rpm

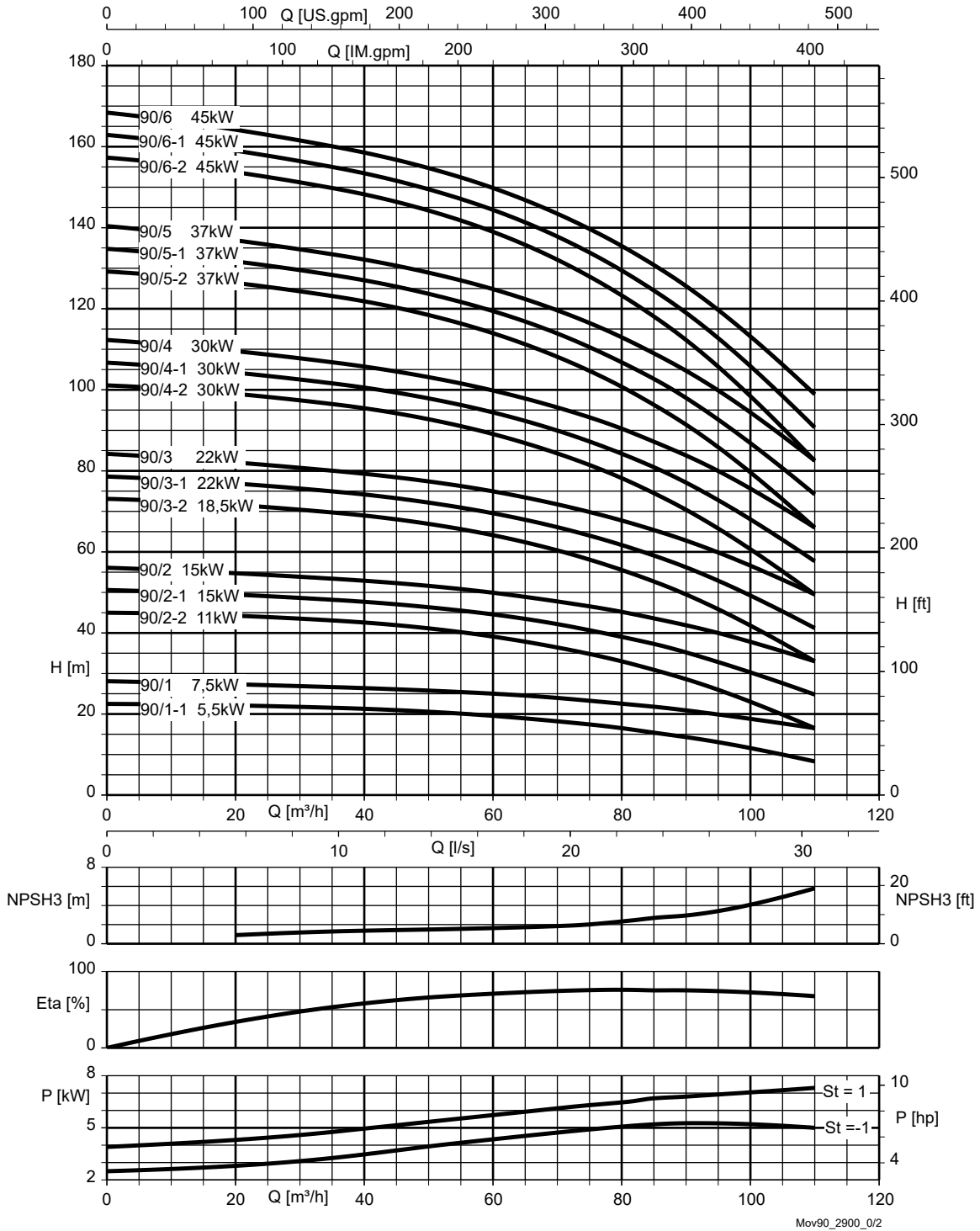

St = 1   P per stage	St = -1   P per stage with a smaller impeller
----------------------	---

Movitec 125B, n = 2900 rpm

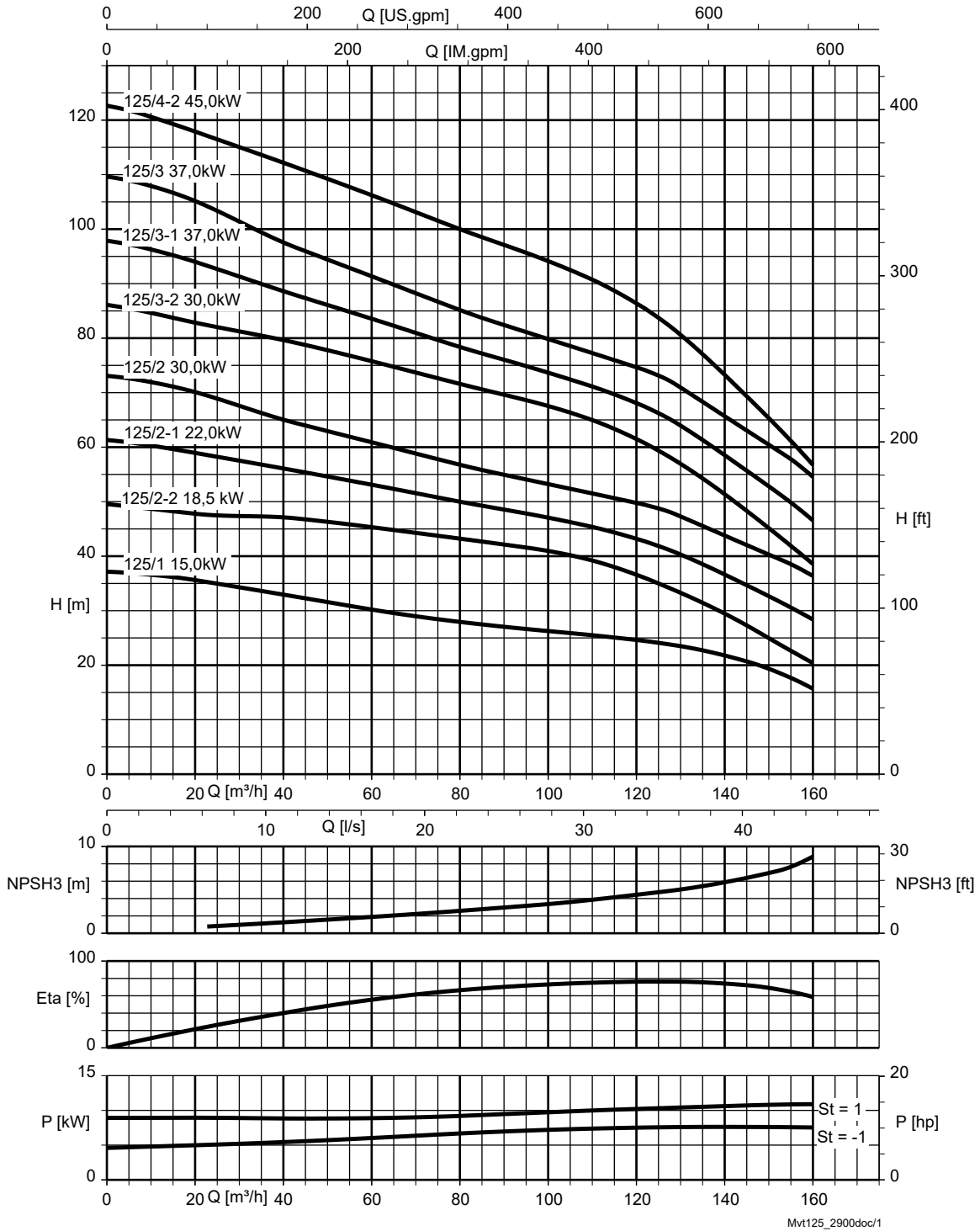

St = 1	P per stage	St = -1	P per stage with a smaller impeller
--------	-------------	---------	-------------------------------------

Movitec LHS, n = 2900 rpm

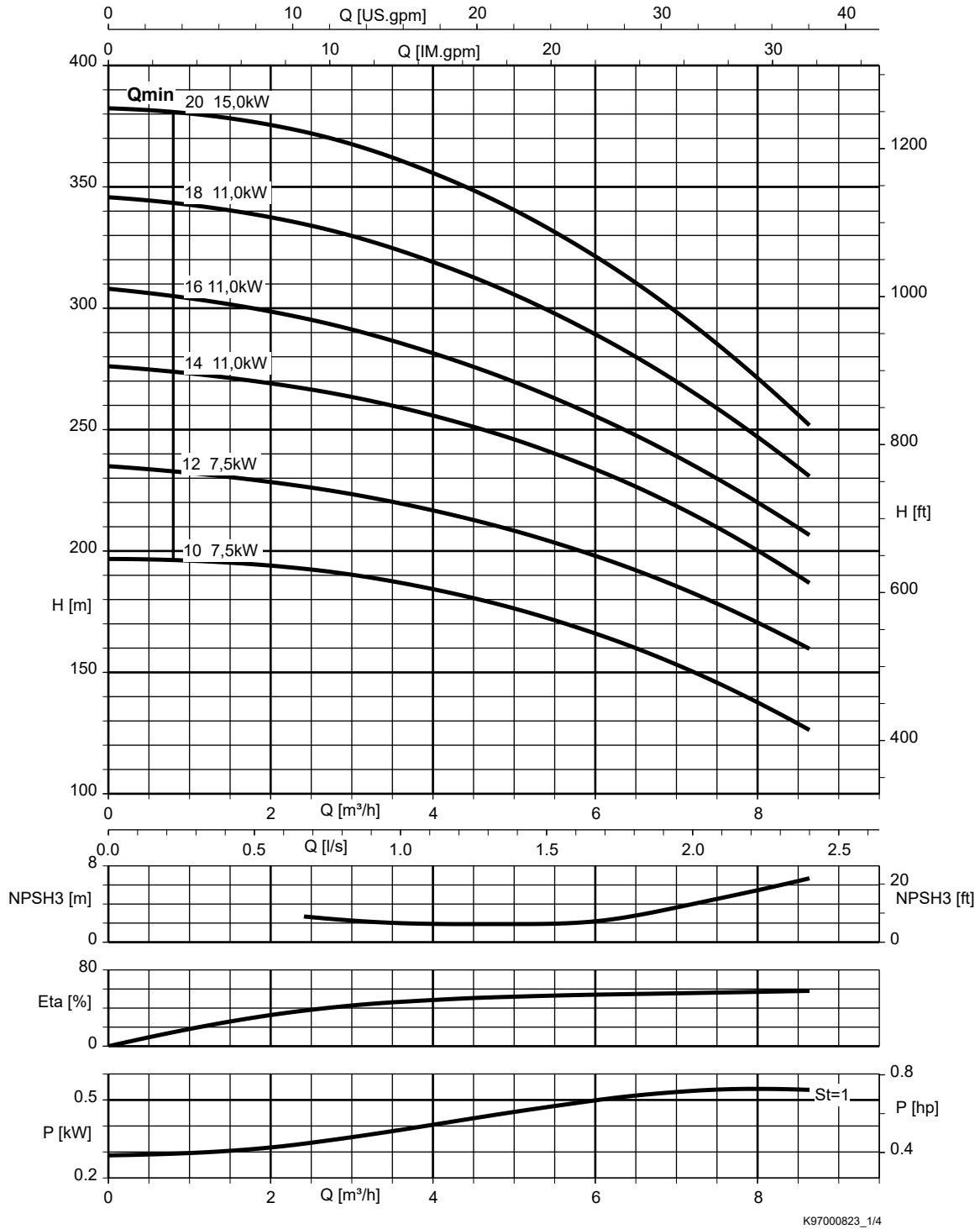

St = 1 | P per stage

\*)  $Q_{min} \leq 40 \text{ }^\circ\text{C}$



n = 1450 rpm

Movitec 10B, n = 1450 rpm

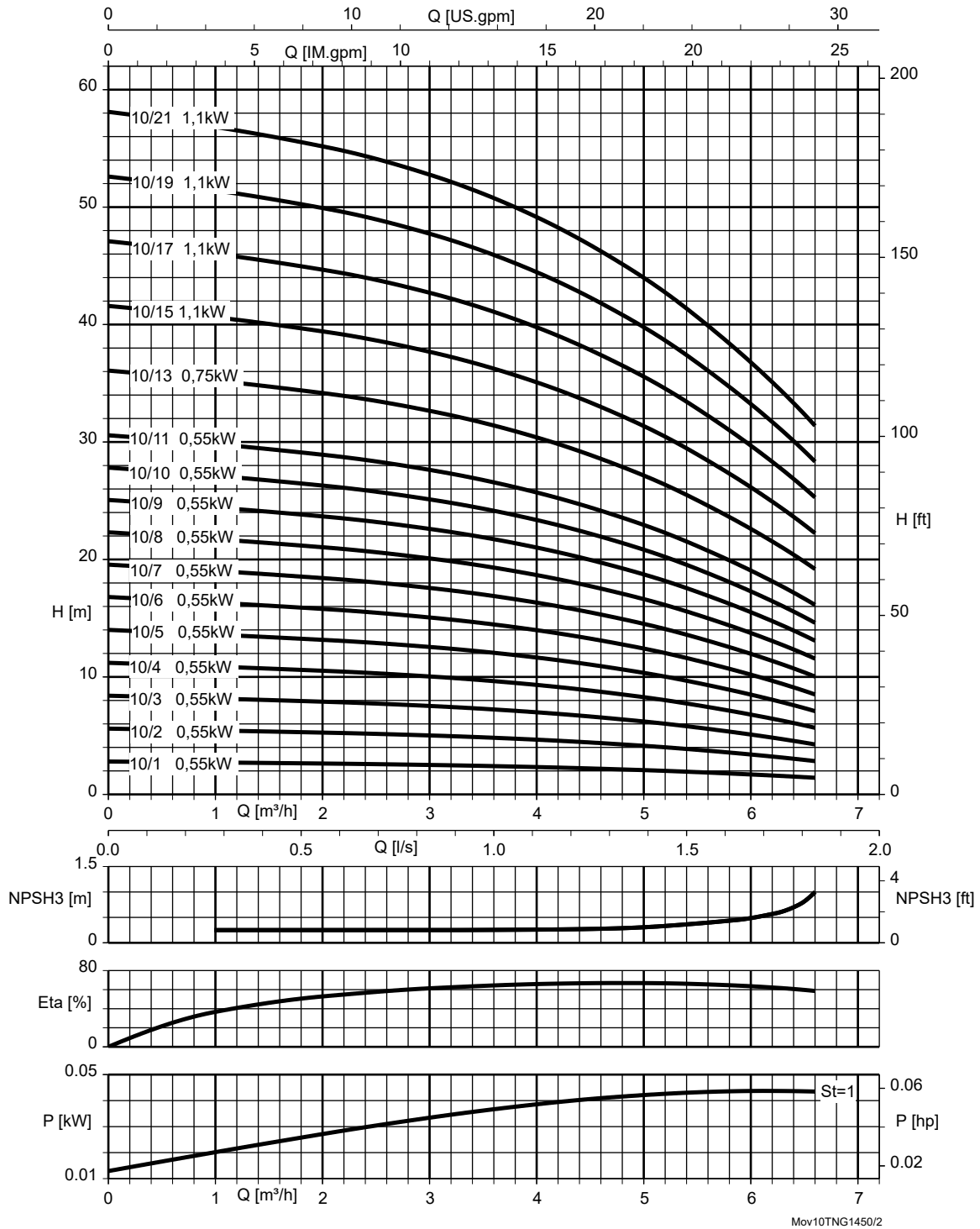

Mov10TNG1450/2

St = 1 | P per stage

Movitec 10LB, n = 1450 rpm

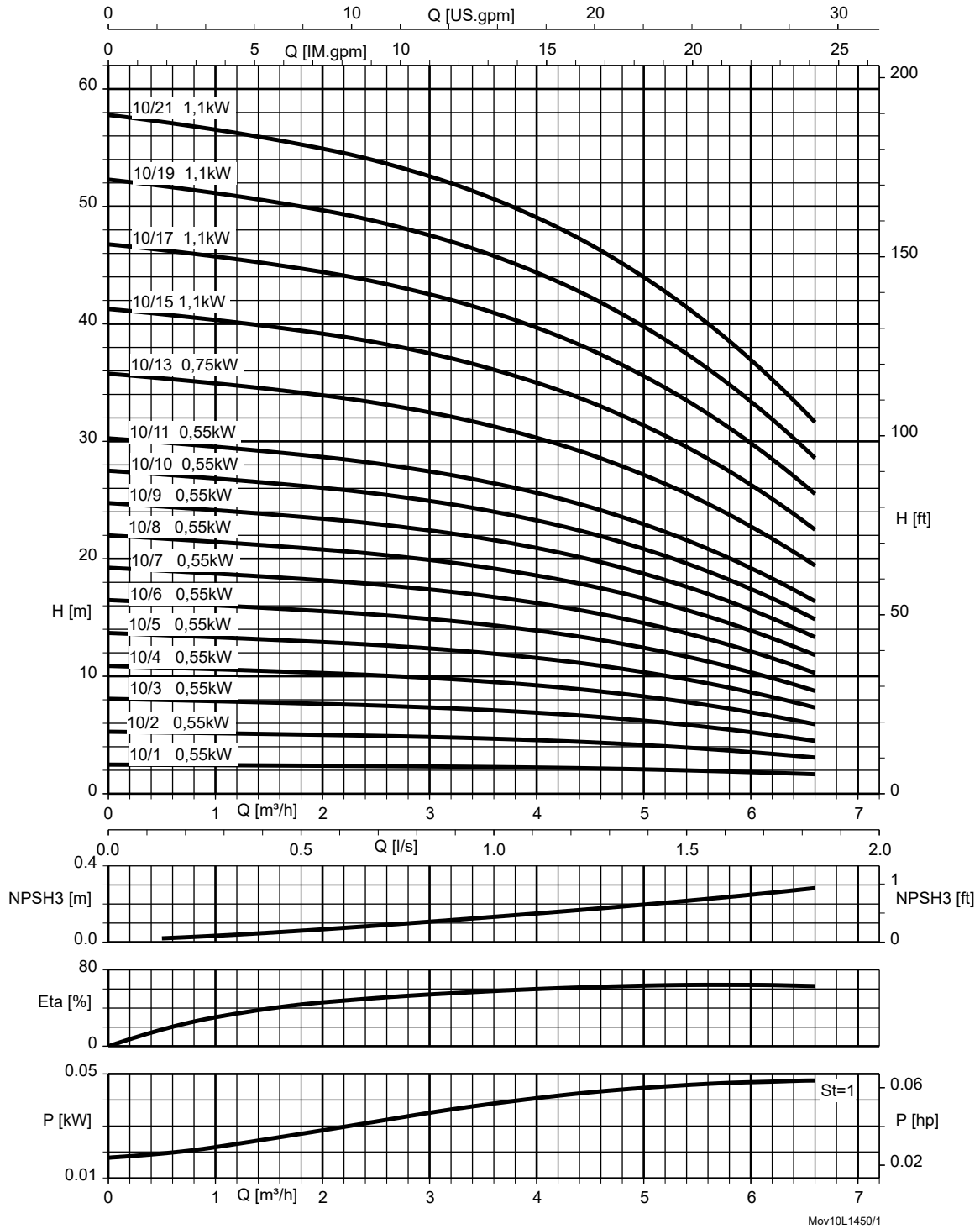

St = 1 | P per stage

1798.52/15-EN

Movitec 15C, n = 1450 rpm

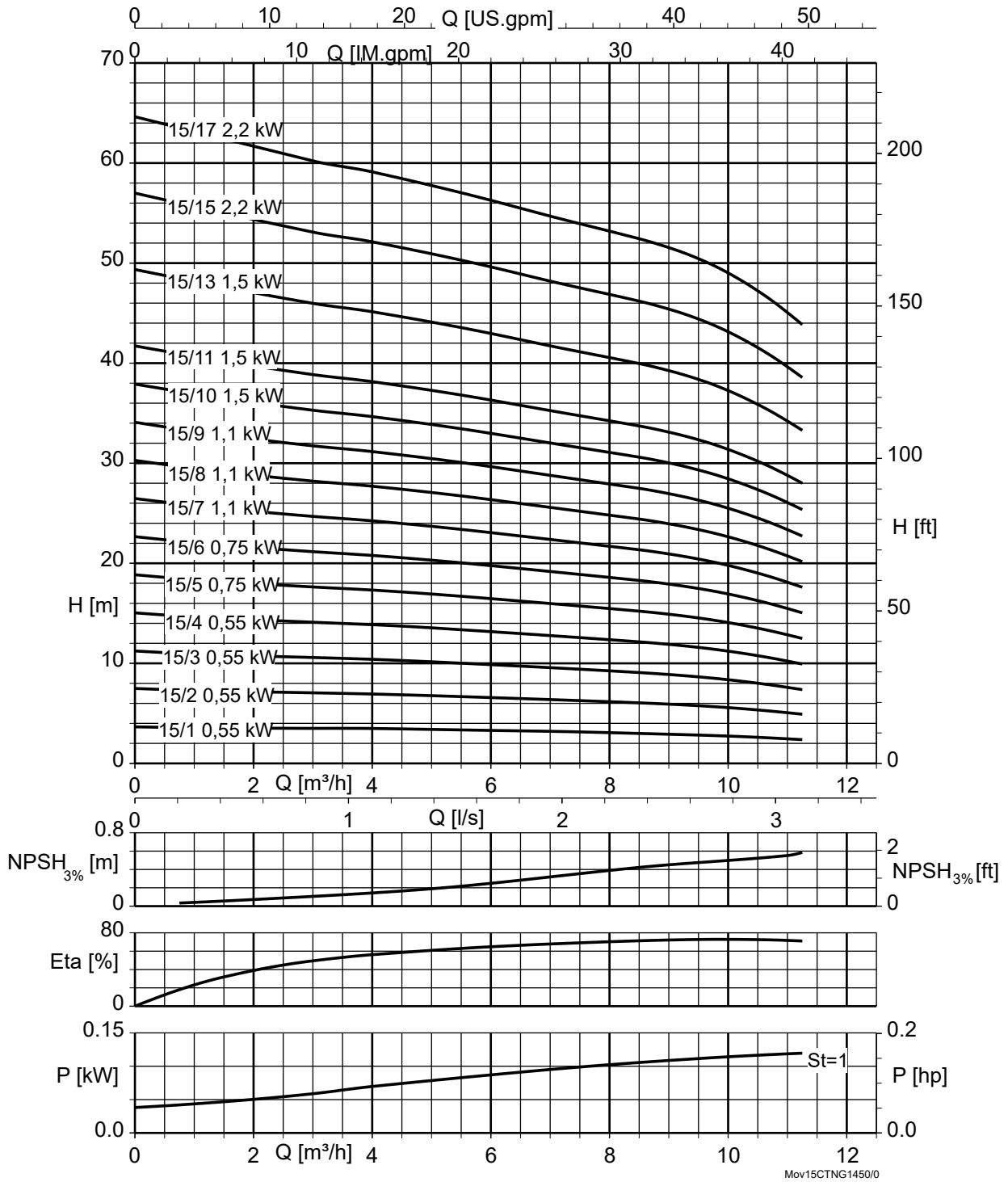

St = 1 | P per stage

Movitec 15LC, n = 1450 rpm

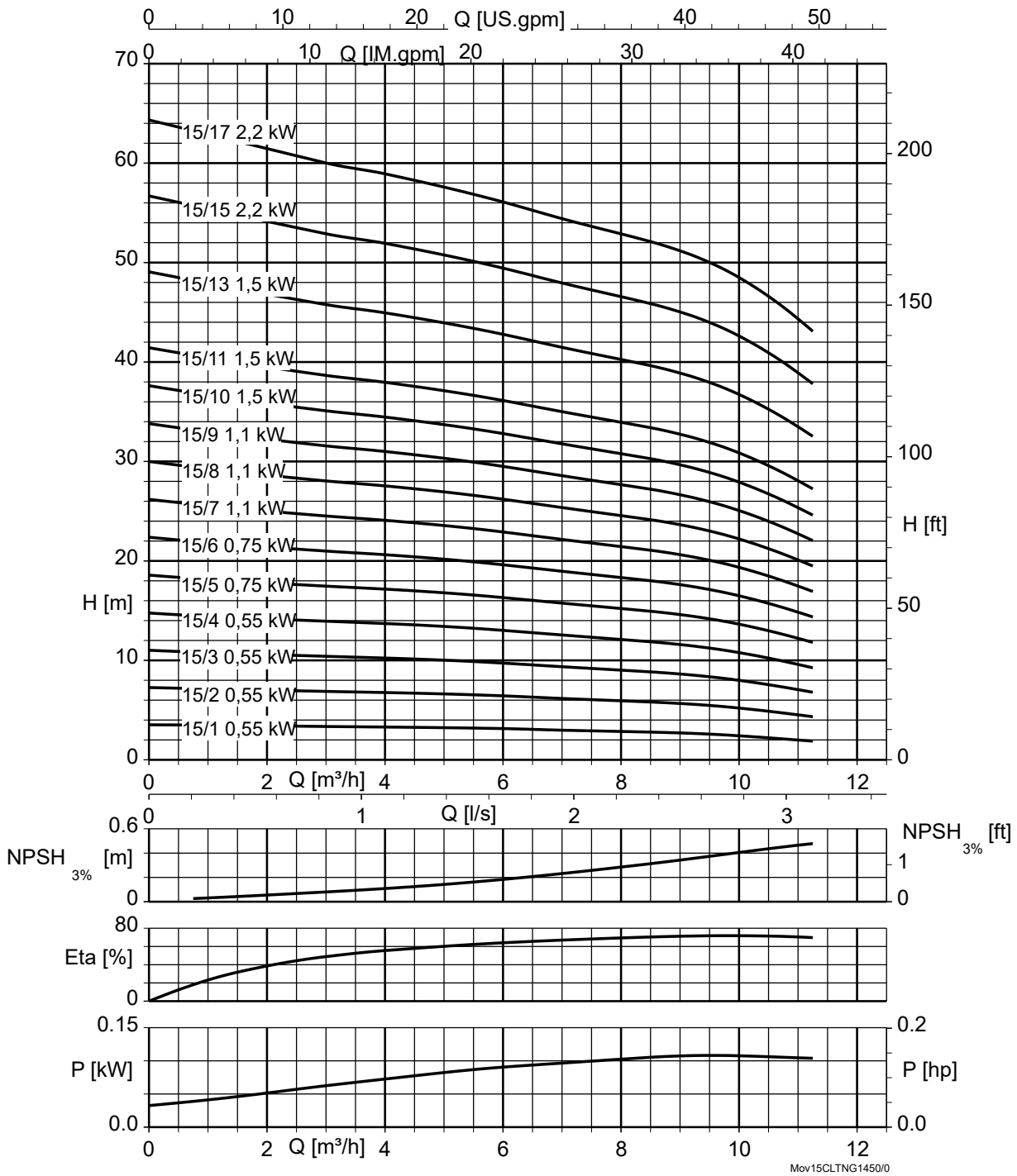

St = 1 | P per stage

Movitec 25B , n = 1450 rpm

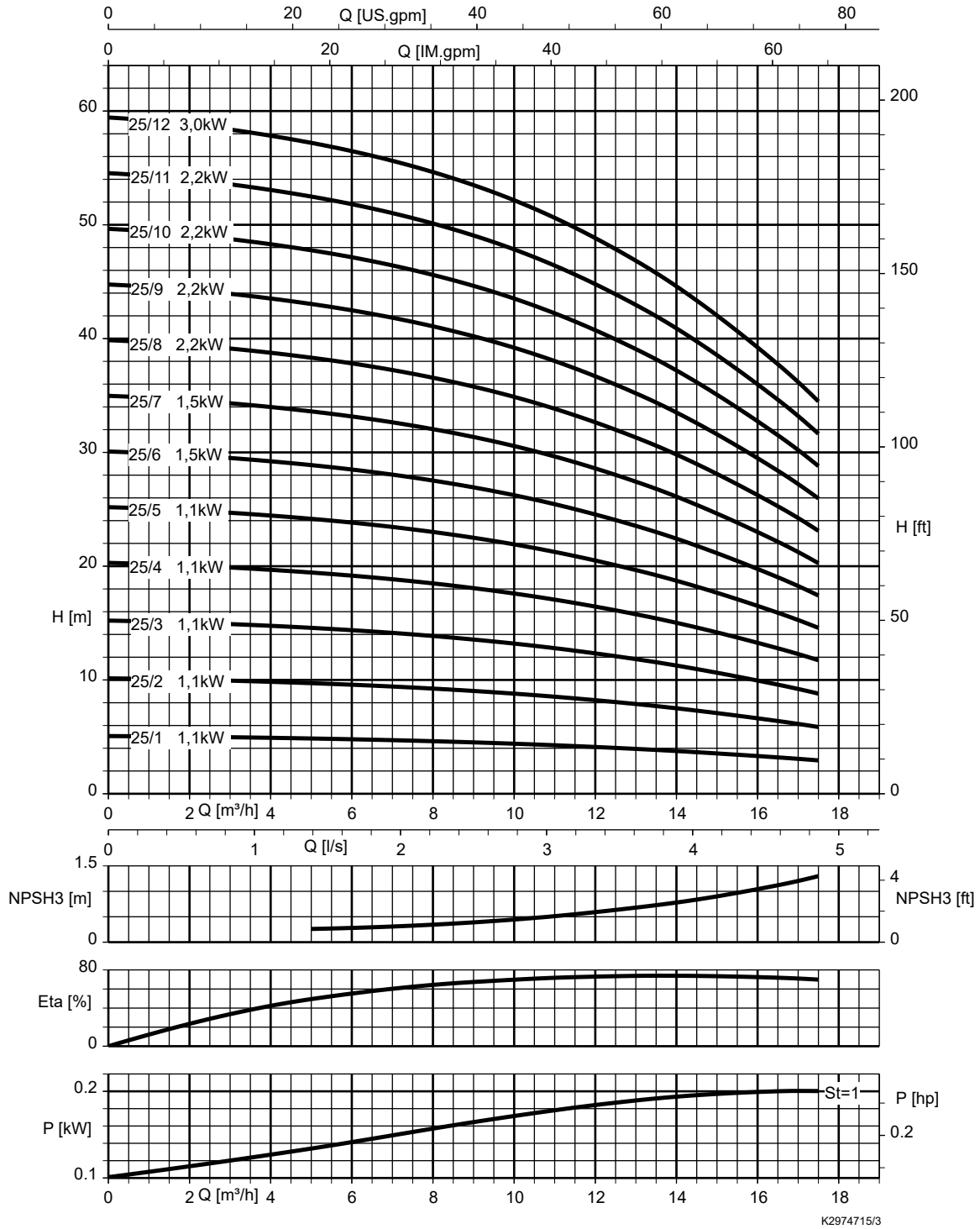

St = 1 | P per stage

Movitec 40B, n = 1450 rpm

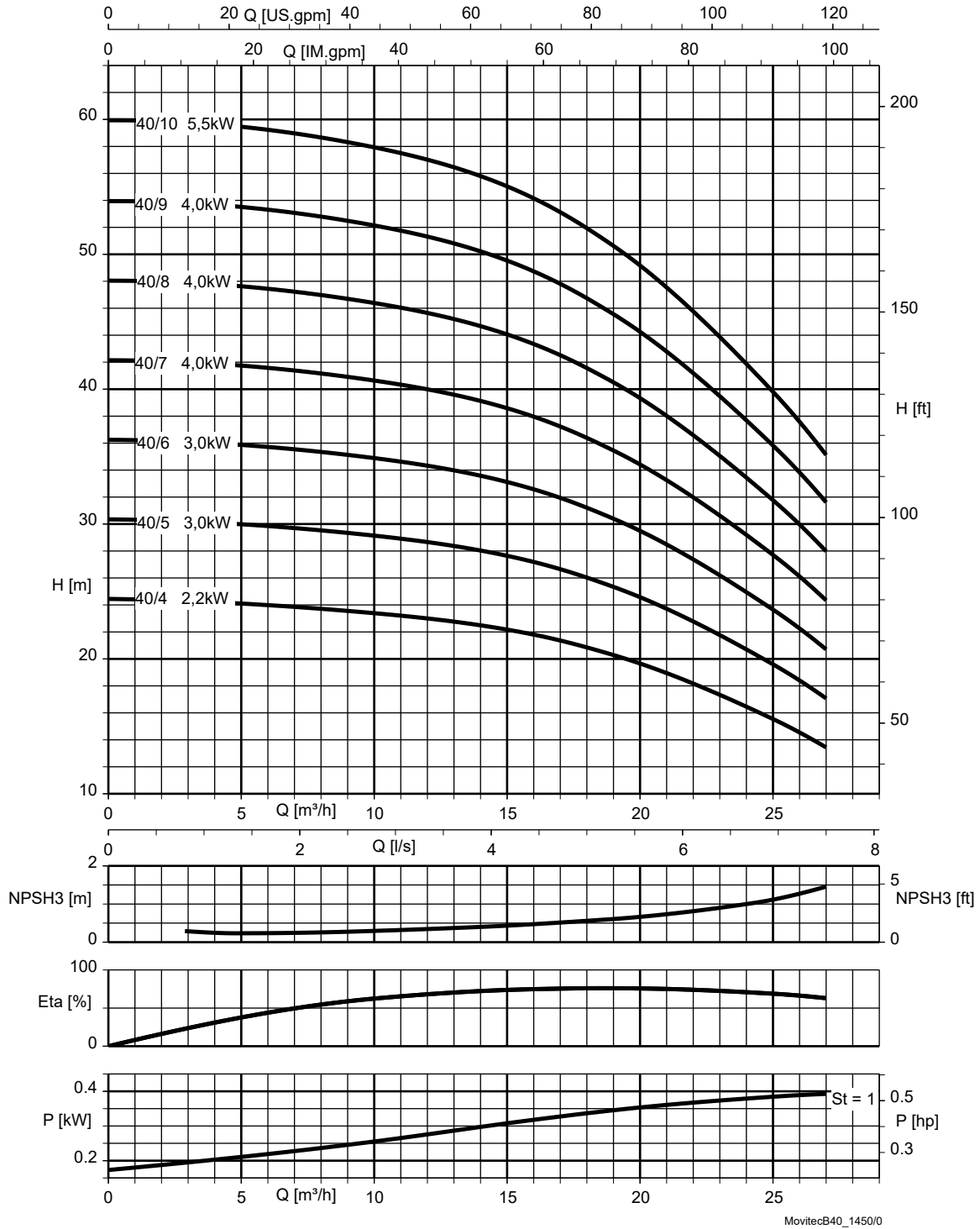

St = 1 | P per stage

Movitec 60B, n = 1450 rpm

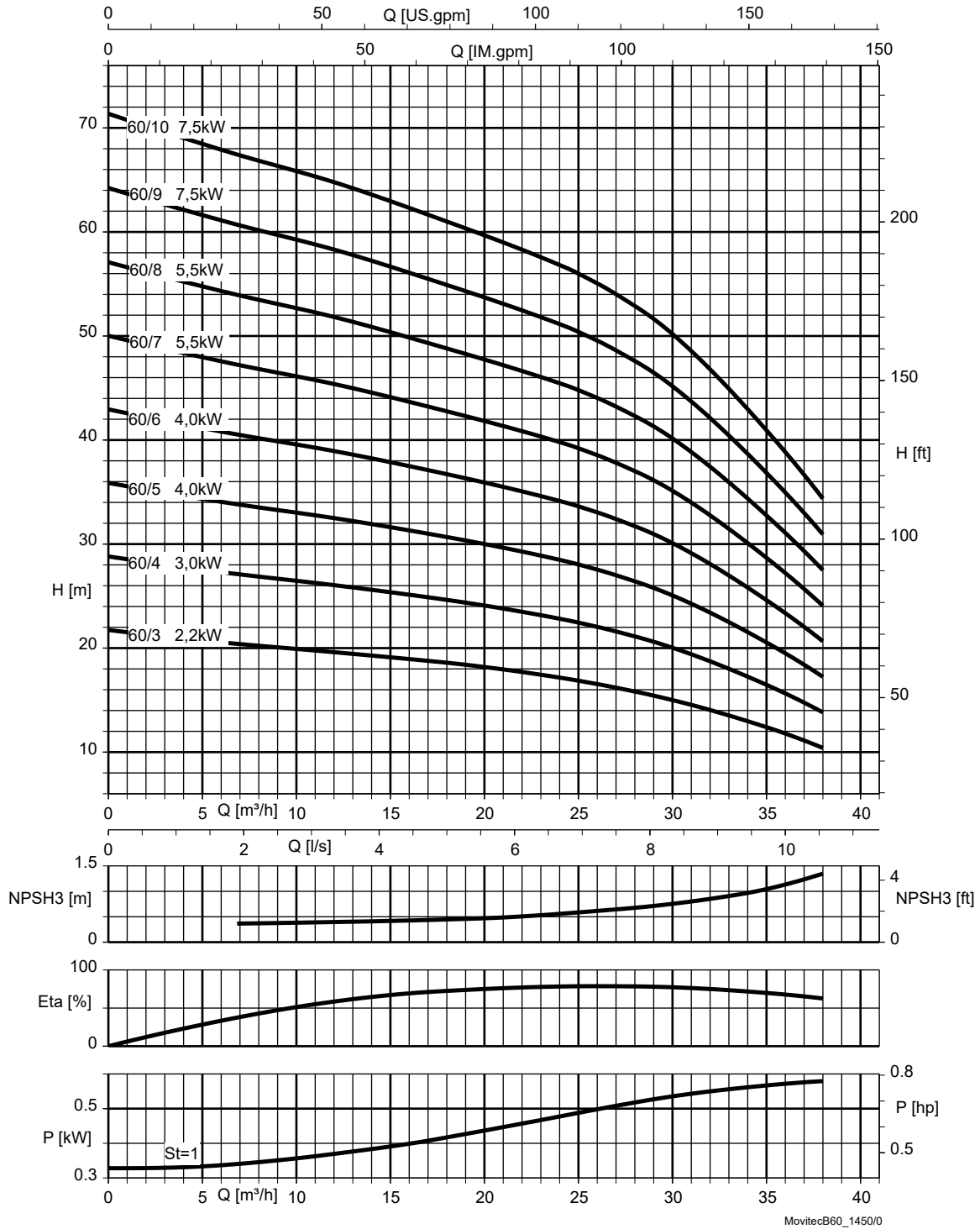

St = 1 | P per stage

Movitec 90B, n = 1450 rpm

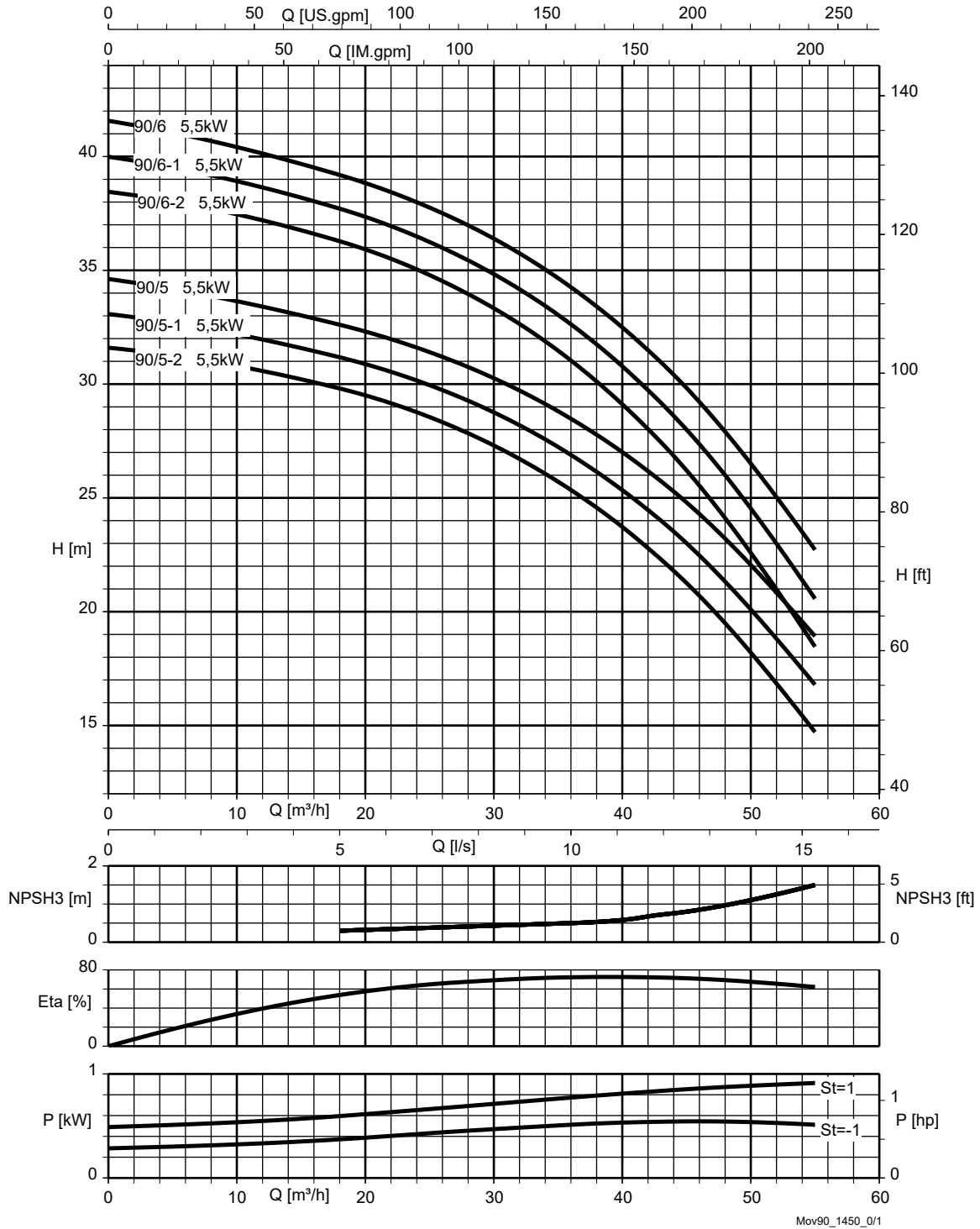

St = 1 | P per stage



Dimensions and connections

Movitec 2(L)B, n = 2900 rpm

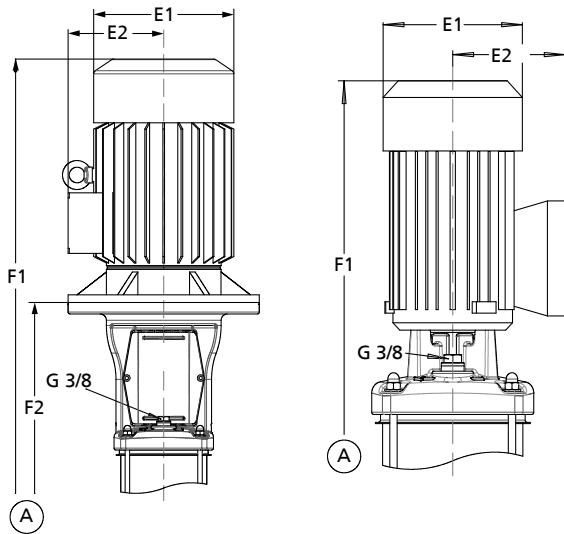

Dimensions of Movitec V(S), VE, V(S)V, V(S)T, V(C/S)F      Dimensions of Movitec V(M)E

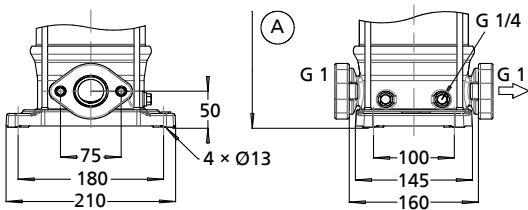

Fig. 4: Connections of Movitec V, VS

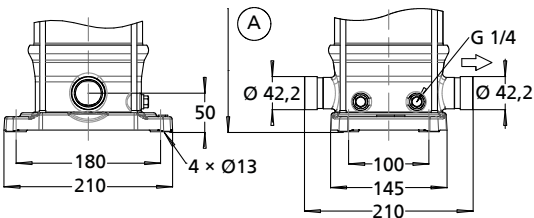

Fig. 5: Connections of Movitec VV, VSV

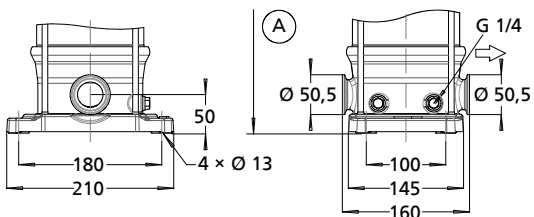

Fig. 6: Connections of Movitec VT, VST

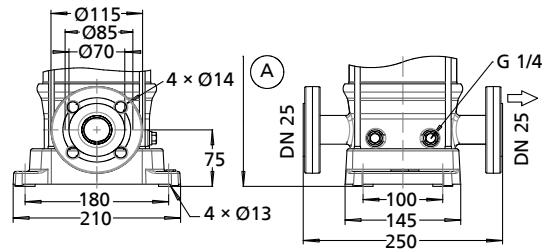

Fig. 7: Connections of Movitec VF, VSF

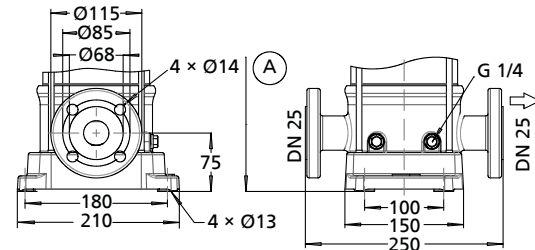

Fig. 8: Connections of Movitec VCF

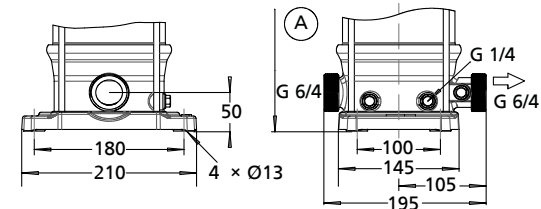

Fig. 9: Connections of Movitec V(M)E

Table 15: Dimensions

Number of stages	P <sub>N</sub> [kW]	E1 [mm]	E2 [mm]	Design				
				V(S) <sup>32</sup> , VE <sup>32</sup> , V(S)V, V(S)T		V(C/S)F		V(M)E
				F1 [mm]	F2 [mm]	F1 [mm]	F2 [mm]	F1 [mm]
2	0,37	138	109	480	259	505	284	420
3	0,37	138	109	501	280	526	305	441
4	0,37	138	109	523	302	548	327	463
5	0,37	138	109	544	323	569	348	484
6	0,55	138	109	566	345	591	370	506
7	0,55	138	109	587	366	612	391	-
8	0,55	138	109	609	388	634	413	-
9	0,75	160	150	651	419	676	444	-
10	0,75	160	150	673	441	698	466	-
11	1,1	160	150	719	462	744	487	-
12	1,1	160	150	741	484	766	509	-
14	1,1	160	150	784	527	809	552	-
16	1,5	185	160	854	580	879	605	-
18	1,5	185	160	897	623	922	648	-
20	1,5	185	160	940	666	965	691	-
22	2,2	185	160	1007	709	1032	734	-
24	2,2	185	160	1050	752	1075	777	-
26	2,2	185	160	1093	795	1118	820	-
28	2,2	185	160	1136	838	1161	863	-
30	2,2	185	160	1179	881	1204	906	-

<sup>32</sup> Available with a maximum of 20 stages

Movitec 4(L)B, n = 2900 rpm

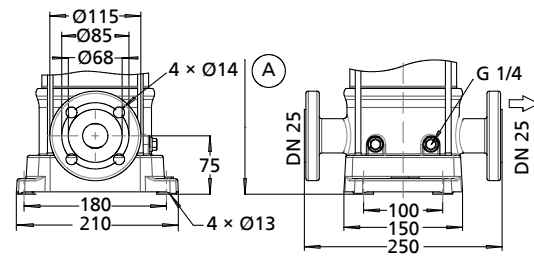
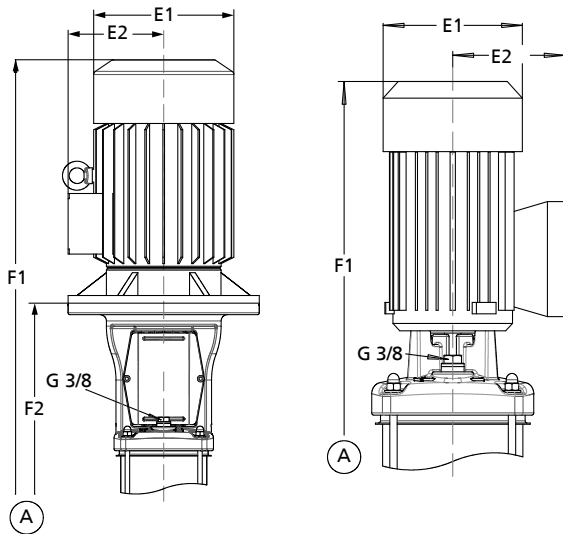

Fig. 14: Connections of Movitec VCF

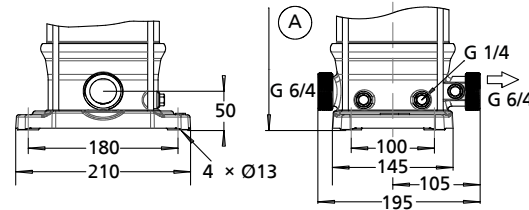

Fig. 15: Connections of Movitec V(M)E

Dimensions of Movitec V(S),  
VE, V(S)V, V(S)T, V(C/S)F

Dimensions of Movitec V(M)E

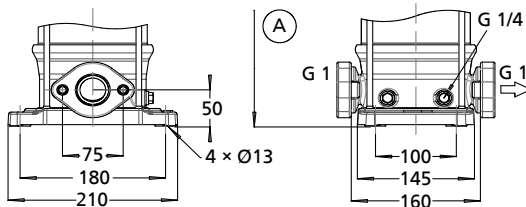

Fig. 10: Connections of Movitec V, VS

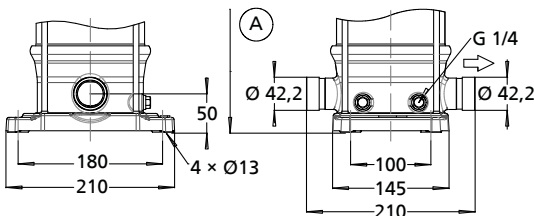

Fig. 11: Connections of Movitec VV, VSV

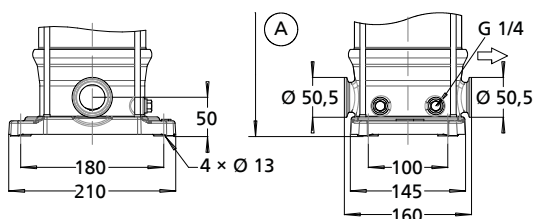

Fig. 12: Connections of Movitec VT, VST

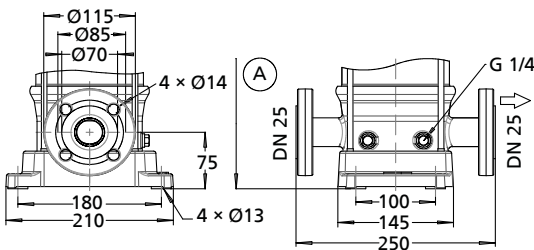

Fig. 13: Connections of Movitec VF, VSF

Table 16: Dimensions

Number of stages	P <sub>N</sub> [kW]	E1 [mm]	E2 [mm]	Design				
				V(S) <sup>33</sup> , VE <sup>33</sup> , V(S)V, V(S)T		V(C/S)F		V(M)E
				F1 [mm]	F2 [mm]	F1 [mm]	F2 [mm]	F1 [mm]
2	0,37	138	109	480	259	505	284	420
3	0,55	138	109	501	280	526	305	441
4	0,55	138	109	523	302	548	327	463
5	0,75	160	150	565	333	590	358	528
6	1,1	160	150	612	355	637	380	556
7	1,1	160	150	633	376	658	401	-
8	1,5	185	160	682	408	707	433	-
9	1,5	185	160	703	429	728	454	-
10	1,5	185	160	725	451	750	476	-
11	2,2	185	160	770	472	795	497	-
12	2,2	185	160	792	494	817	519	-
14	2,2	185	160	835	537	860	562	-
16	3,0	185	160	908	590	933	615	-
18	3,0	205	175	951	633	976	658	-
20	3,0	205	175	994	676	1019	701	-
22	4,0	220	190	1031	719	1059	744	-
24	4,0	220	190	1077	762	1102	787	-
26	4,0	220	190	1120	805	1145	830	-

<sup>33</sup> Available with a maximum of 16 stages

Movitec 6(L)B, n = 2900 rpm

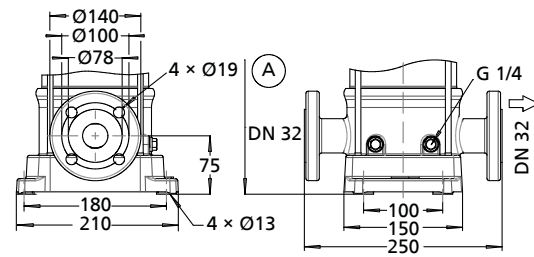
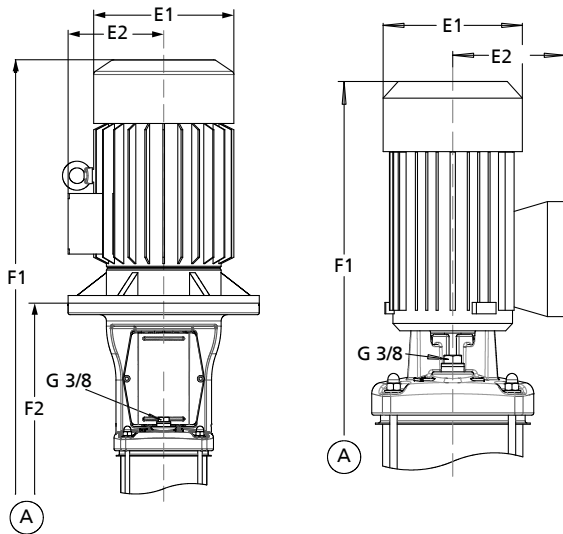

Fig. 20: Connections of Movitec VCF

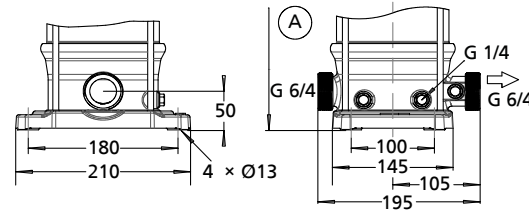

Fig. 21: Connections of Movitec V(M)E

Dimensions of Movitec V(S),  
VE, V(S)V, V(S)T, V(C/S)F

Dimensions of Movitec V(M)E

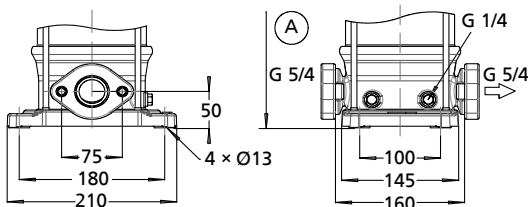

Fig. 16: Connections of Movitec V, VS

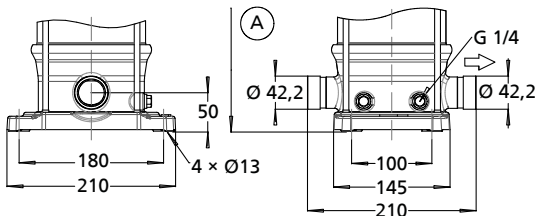

Fig. 17: Connections of Movitec VV, VSV

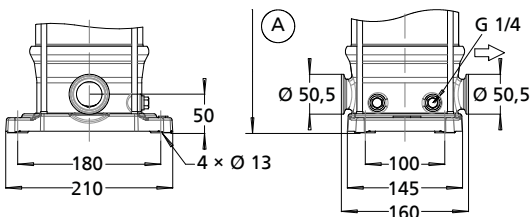

Fig. 18: Connections of Movitec VT, VST

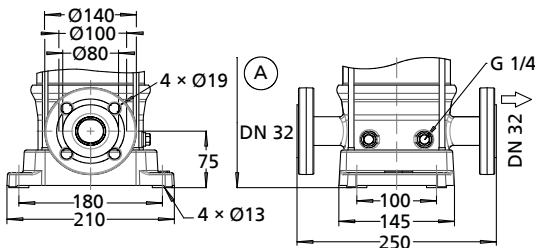

Fig. 19: Connections of Movitec VF, VSF

Table 17: Dimensions

Number of stages	P <sub>N</sub> [kW]	E1 [mm]	E2 [mm]	Design				
				V(S) <sup>34</sup> , VE <sup>34</sup> , V(S)V, V(S)T		V(C/S)F		V(M)E
				F1 [mm]	F2 [mm]	F1 [mm]	F2 [mm]	F1 [mm]
2	0,37	138	109	487	266	512	291	426
3	0,75	160	150	533	301	558	326	496
4	1,1	160	150	583	326	608	351	521
5	1,1	160	150	608	351	633	376	546
6	1,5	185	160	660	386	685	411	-
7	1,5	185	160	685	411	710	436	-
8	2,2	185	160	734	436	759	461	-
9	2,2	185	160	759	461	784	486	-
10	2,2	185	160	784	486	809	511	-
11	3,0	205	175	839	521	864	546	-
12	3,0	205	175	864	546	889	571	-
14	3,0	205	175	914	596	939	621	-
16	4,0	220	190	961	646	986	671	-
18	4,0	220	190	1011	696	1036	721	-
20	5,5	260	220	1224	822	1249	847	-
22	5,5	260	220	1274	872	1299	897	-
24	5,5	260	220	1324	922	1349	947	-
26	5,5	260	220	1374	972	1399	997	-

<sup>34</sup> Available with a maximum of 16 stages

Movitec 10(L)B, n = 1450 rpm

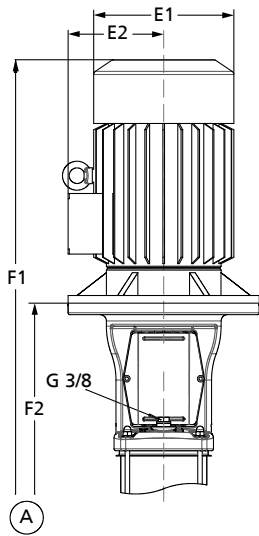

Dimensions of Movitec V(S), V(S)V, V(S)T, V(C/S)F

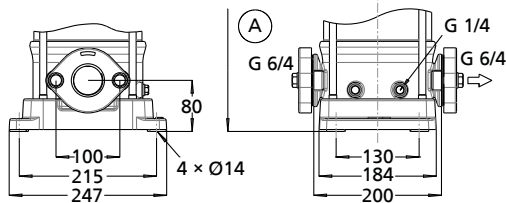

Fig. 22: Connections of Movitec V, VS

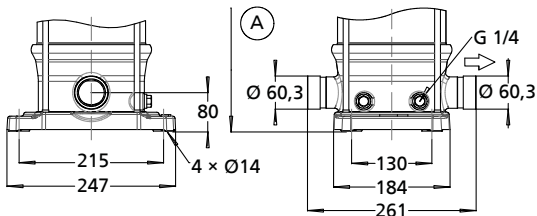

Fig. 23: Connections of Movitec VV, VSV

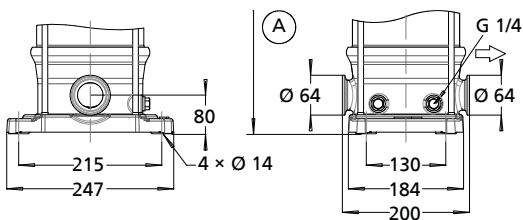

Fig. 24: Connections of Movitec VT, VST

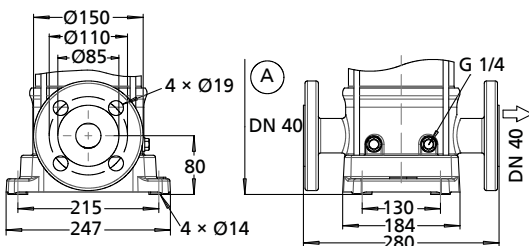

Fig. 25: Connections of Movitec VF, VSF

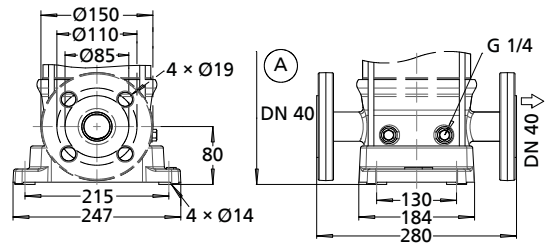
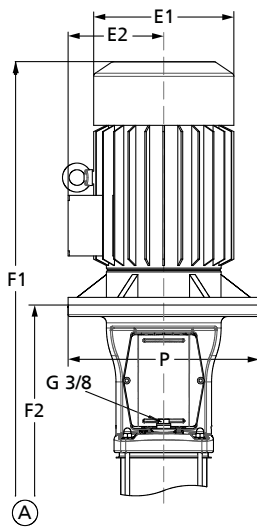

Fig. 26: Connections of Movitec VCF

Table 18: Dimensions

Number of stages	P <sub>N</sub> [kW]	E1 [mm]	E2 [mm]	Design			
				V(S), VE, V(S)V, V(S)T		V(C/S)F	
				F1 [mm]	F2 [mm]	F1 [mm]	F2 [mm]
1	0,55	157	112	603	346	603	346
2	0,55	157	112	603	346	603	346
3	0,55	157	112	629	372	629	372
4	0,55	157	112	656	399	656	399
5	0,55	157	112	682	425	682	425
6	0,55	157	112	709	452	709	452
7	0,55	157	112	735	478	735	478
8	0,55	157	112	762	505	762	505
9	0,55	157	112	788	531	788	531
10	0,55	157	112	815	558	815	558
11	0,55	157	112	841	584	841	584
13	0,75	157	133	967	672	967	672
15	1,1	180	145	975	700	975	700
17	1,1	180	145	1028	753	1028	753
19	1,1	180	145	1081	806	1081	806
21	1,1	180	145	1134	859	1134	859

Movitec 10(L)B, n = 2900 rpm



Dimensions of Movitec V(S), V(S)V, V(S)T, V(C/S)F

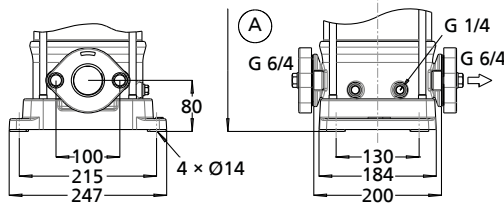

Fig. 27: Connections of Movitec V, VS

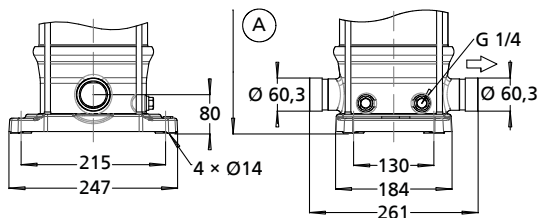

Fig. 28: Connections of Movitec VV, VSV

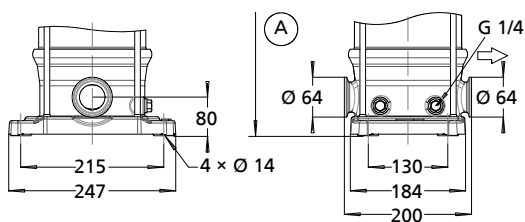

Fig. 29: Connections of Movitec VT, VST

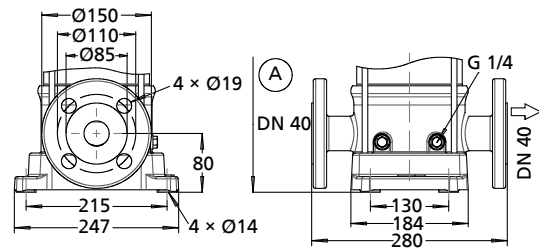

Fig. 30: Connections of Movitec VF, VSF

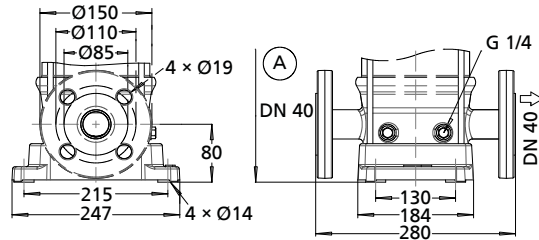

Fig. 31: Connections of Movitec VCF

Table 19: Dimensions

Number of stages	P <sub>N</sub> [kW]	E1 [mm]	E2 [mm]	P [mm]	Design			
					V(S), VE <sup>35</sup> , V(S)V, V(S)T		V(C/S)F	
					F1 [mm]	F2 [mm]	F1 [mm]	F2 [mm]
1	0,75	157	133	-	578	346	578	578
2	0,75	157	133	-	578	346	526	578
3	1,1	157	133	-	629	372	548	629
4	1,5	200	148	-	690	409	569	690
5	2,2	200	148	-	716	435	591	716
6	2,2	200	148	-	743	462	612	743
7	3,0	215	157	-	815	498	634	815
8	3,0	215	157	-	842	525	676	842
9	4,0	248	168	-	907	551	698	907
10	4,0	248	168	-	934	578	744	934
11	4,0	248	168	-	960	604	766	960
13	5,5	288	197	300	1169	737	809	1169
15	5,5	288	197	300	1222	790	879	1222
17	7,5	288	197	300	1275	843	922	1275
19	7,5	288	197	300	1328	896	965	1328
21	7,5	288	197	300	1381	949	1032	1381

<sup>35</sup> Available with a maximum of 13 stages

Movitec 15(L)C, n = 1450 rpm

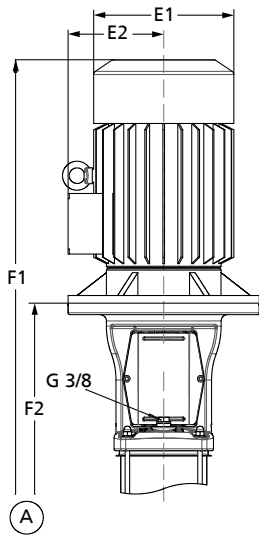

Dimensions of Movitec V(S), V(S)V, V(S)T, V(C/S)F

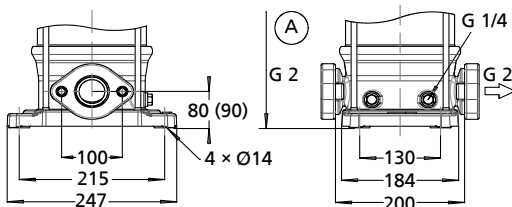

Fig. 32: Connections of Movitec V, VS

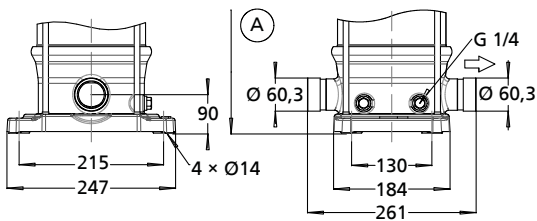

Fig. 33: Connections of Movitec VV, VSV

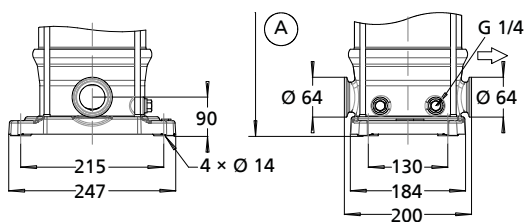

Fig. 34: Connections of Movitec VT, VST

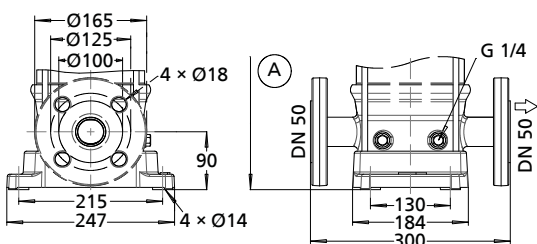

Fig. 35: Connections of Movitec VF, VSF

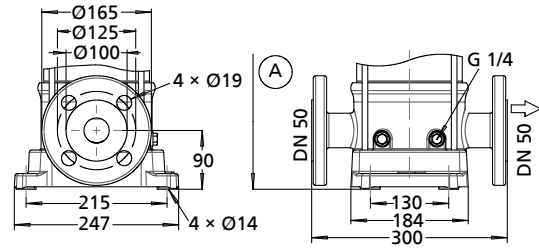
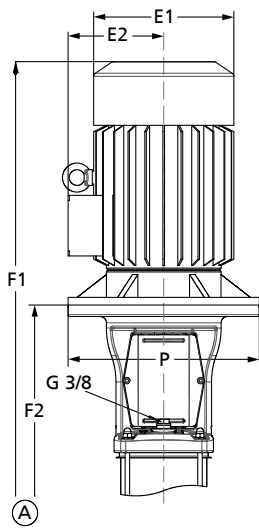

Fig. 36: Connections of Movitec VCF

Table 20: Dimensions

Number of stages	P <sub>N</sub> [kW]	E1 [mm]	E2 [mm]	Design			
				V(S), VE, V(S)V, V(S)T		V(C/S)F	
				F1 [mm]	F2 [mm]	F1 [mm]	F2 [mm]
1	0,55	157	112	619	362	629	372
2	0,55	157	112	619	362	629	372
3	0,55	157	112	660	403	670	413
4	0,55	157	112	701	444	711	454
5	0,75	157	112	780	485	790	495
6	0,75	157	133	821	526	831	536
7	1,1	180	145	852	577	862	587
8	1,1	180	145	893	618	903	628
9	1,1	180	145	934	659	944	669
10	1,5	180	145	1000	700	1010	710
11	1,5	180	145	1041	741	1051	751
13	1,5	180	145	1123	823	1133	833
15	2,2	200	155	1233	915	1243	925
17	2,2	200	155	1315	997	1325	1007

Movitec 15(L)C, n = 2900 rpm



Dimensions of Movitec V(S), V(S)V, V(S)T, V(C/S)F

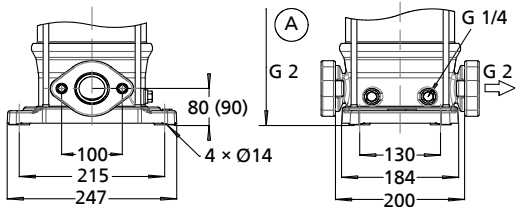

Fig. 37: Connections of Movitec V, VS

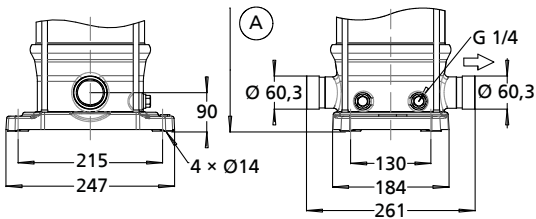

Fig. 38: Connections of Movitec VV, VSV

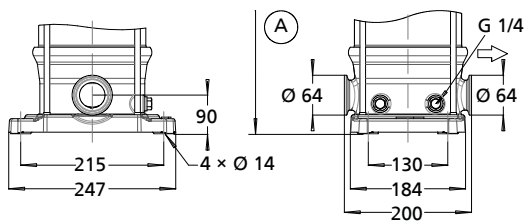

Fig. 39: Connections of Movitec VT, VST

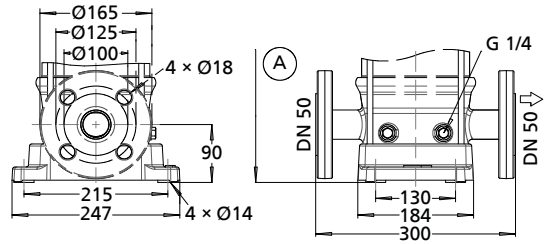

Fig. 40: Connections of Movitec VF, VSF

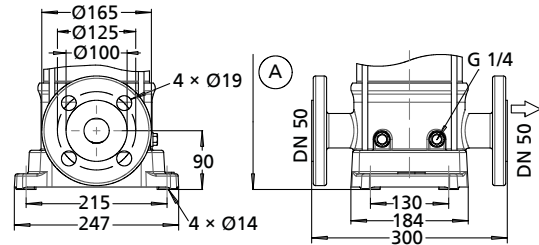

Fig. 41: Connections of Movitec VCF

Table 21: Dimensions

Number of stages	P <sub>N</sub> [kW]	E1 [mm]	E2 [mm]	P [mm]	Design			
					V(S), VE <sup>36</sup> , V(S)V, V(S)T		V(C/S)F	
					F1 [mm]	F2 [mm]	F1 [mm]	F2 [mm]
1	1,1	157	133	-	619	362	629	372
2	2,2	200	148	-	653	372	663	382
3	3,0	215	157	-	740	423	750	433
4	4,0	248	168	-	820	464	830	474
5	5,5	288	197	300	1017	585	1027	595
6	7,5	288	197	300	1058	626	1068	636
7	7,5	288	197	300	1099	667	1109	677
8	11,0	340	223	350	1271	738	1281	748
9	11,0	340	223	350	1312	779	1322	789
10	11,0	340	223	350	1353	820	1363	830
11	11,0	340	223	350	-	-	1404	871
13	15,0	340	223	350	-	-	1486	953
15	15,0	340	223	350	-	-	1568	1035
17	18,5	340	223	350	-	-	1650	1117

<sup>36</sup> Available with a maximum of 10 stages

Movitec 25B , n = 1450 rpm

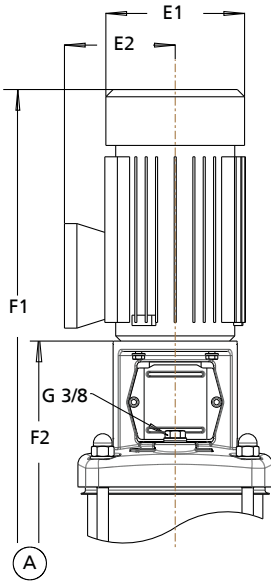

Dimensions of Movitec V(C/S)F

**i** Motor flange version with tapped hole

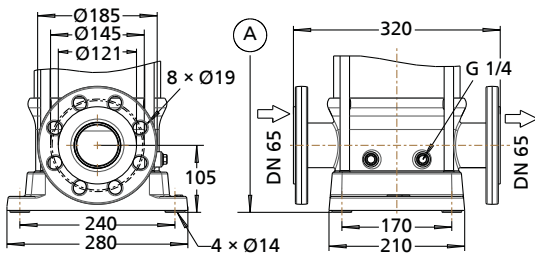

Fig. 42: Connections of Movitec VF, VSF

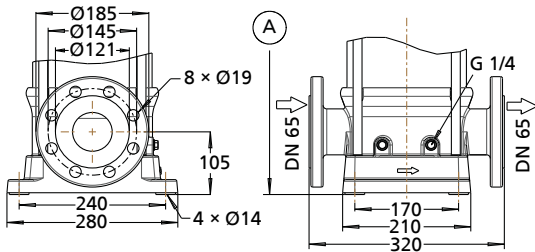

Fig. 43: Connections of Movitec VCF

Table 22: Dimensions

Number of stages	P <sub>N</sub> [kW]	E1 [mm]	E2 [mm]	Design	
				V(C/S)F	
				F1 [mm]	F2 [mm]
1	1,1	180	145	683	408
2	1,1	180	145	748	473
3	1,1	180	145	813	538
4	1,1	180	145	878	603
5	1,1	180	145	943	668
6	1,5	180	145	1033	733
7	1,5	180	145	1098	798
8	2,2	200	155	1186	868
9	2,2	200	155	1251	933
10	2,2	200	155	1316	998
11	2,2	200	155	1381	1063
12	3,0	200	155	1490	1128



Movitec 25B, n = 2900 rpm

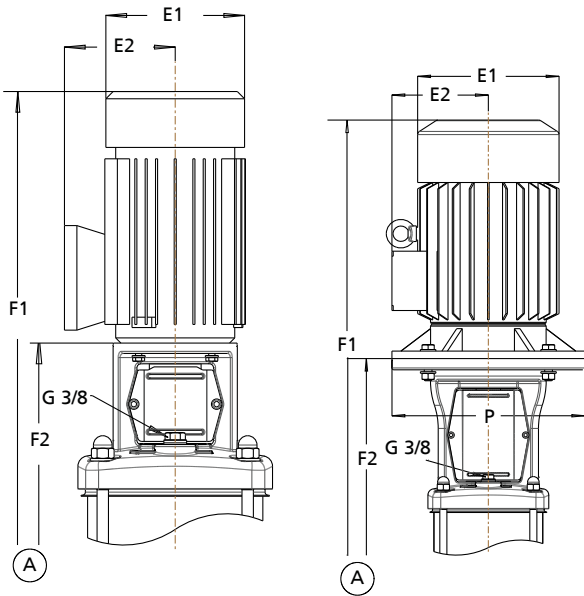

Number of stages	P <sub>N</sub>	E1	E2	P	Design	
					V(C/S)F	
	[kW]	[mm]	[mm]	[mm]	F1	F2
6	11,0	315	260	350	1363	859
7	15,0	315	260	350	1428	924
8	15,0	315	260	350	1493	989
9	15,0	315	260	350	1558	1054
10	18,5	315	265	350	1667	1119
11	18,5	315	265	350	1732	1184
12	22,0	360	275	350	1824	1249

Dimensions of Movitec V(C/S)F Dimensions of Movitec V(C/S)F

**i** Motor flange version with tapped holes **i** Motor flange version with clearance holes

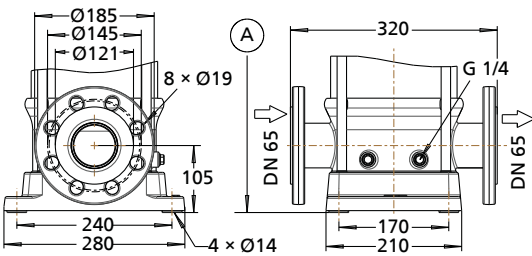

Fig. 44: Connections of Movitec VF, VSF

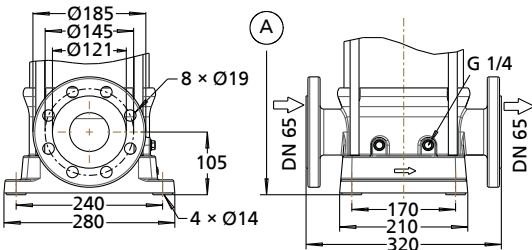

Fig. 45: Connections of Movitec VCF

Table 23: Dimensions (motor flange version with tapped holes)

Number of stages	P <sub>N</sub>	E1	E2	P	Design	
					V(C/S)F	
	[kW]	[mm]	[mm]	[mm]	F1	F2
1	2,2	180	190	-	706	408
2	4,0	223	190	190	793	478

Table 24: Dimensions (motor flange version with clearance holes)

Number of stages	P <sub>N</sub>	E1	E2	P	Design	
					V(C/S)F	
	[kW]	[mm]	[mm]	[mm]	F1	F2
3	5,5	260	260	300	1036	634
4	7,5	260	260	300	1099	699
5	11,0	315	260	350	1298	794

1798.52/15-EN

Movitec 40B, n = 1450 rpm

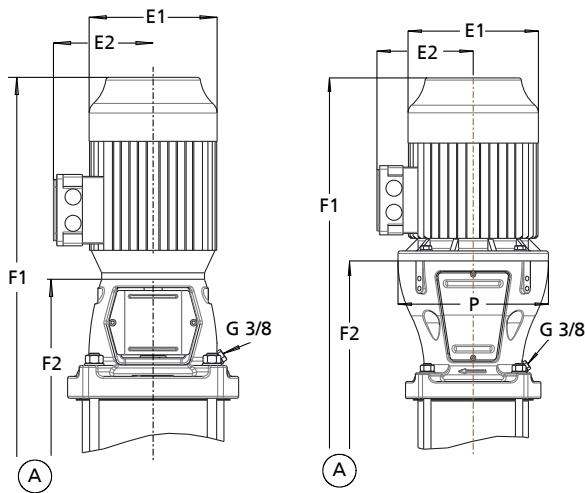

Dimensions of Movitec V(C/S)F      Dimensions of Movitec V(C/S)F

**i** Motor version V18

**i** Motor version V1

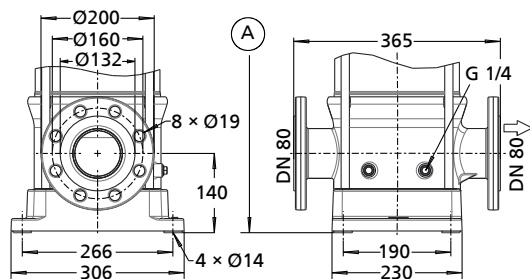

Fig. 46: Connections of Movitec VF, VSF

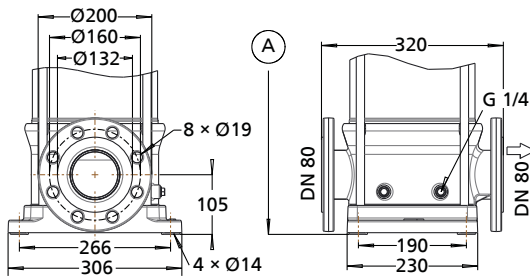

Fig. 47: Connections of Movitec VF, VSF - interchangeable range

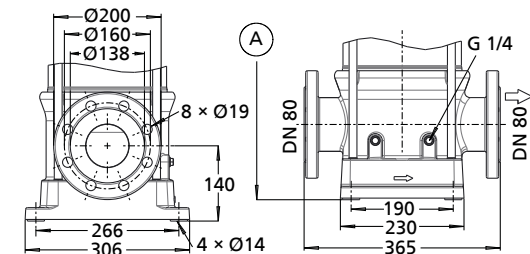

Fig. 48: Connections of Movitec VCF

Table 25: Dimensions (motor flange version with tapped holes)

Number of stages	P <sub>N</sub> [kW]	E1 [mm]	E2 [mm]	P [mm]	Design V(C/S)F	
					F1 [mm]	F2 [mm]
	4	2,2	200	155	-	1039
5	3,0	200	155	-	1161	799
6	3,0	200	155	-	1239	877
7	4,0	233	166	-	1270	955
8	4,0	233	166	-	1348	1033
9	4,0	233	166	-	1426	1111

Table 26: Dimensions (motor flange version with clearance holes)

Number of stages	P <sub>N</sub> [kW]	E1 [mm]	E2 [mm]	P [mm]	Design V(C/S)F	
					F1 [mm]	F2 [mm]
	10	5,5	260	190	300	1679

Movitec 40B, n = 2900 rpm

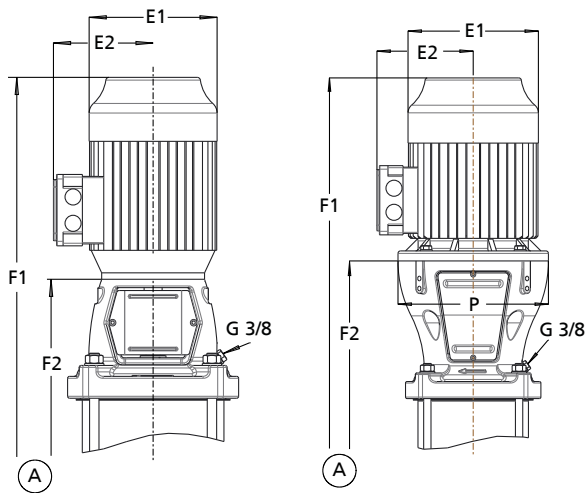

Dimensions of Movitec V(C/S)F      Dimensions of Movitec V(C/S)F

**i** Motor version V18

**i** Motor version V1

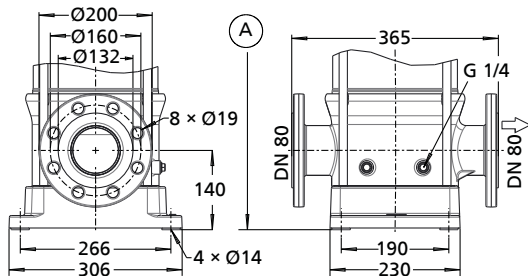

Fig. 49: Connections of Movitec VF, VSF (PN 16, PN 25)

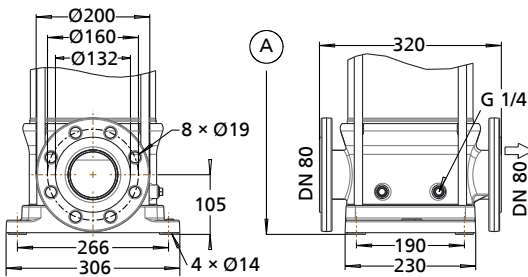

Fig. 50: Connections of Movitec VF, VSF (PN 16, PN 25 - interchangeable range)

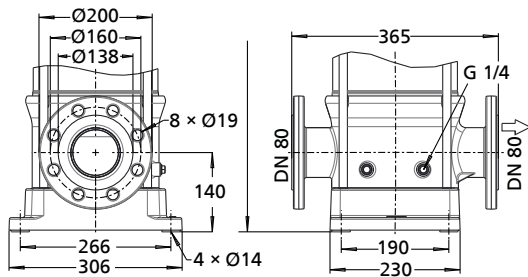

Fig. 51: Connections of Movitec VF, VSF (PN 40)

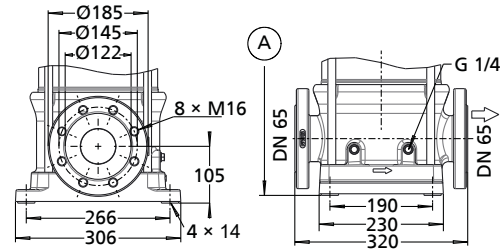

Fig. 52: Connections of Movitec VCF (DN 65)

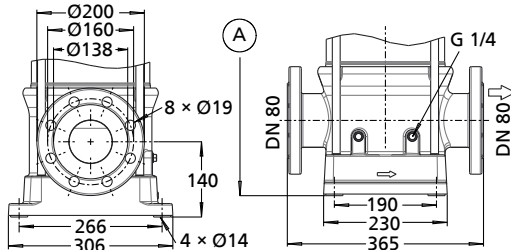

Fig. 53: Connections of Movitec VCF (DN 80)

Table 27: Dimensions (motor flange version with tapped holes)

Number of stages	P <sub>N</sub> [kW]	E1 [mm]	E2 [mm]	P [mm]	Design V(C/S)F	
					F1 [mm]	F2 [mm]
					1-1	3,0
1	4,0	223	166	-	802	487

Table 28: Dimensions (motor flange version with clearance holes)

Number of stages	P <sub>N</sub> [kW]	E1 [mm]	E2 [mm]	P [mm]	Design V(C/S)F	
					F1 [mm]	F2 [mm]
					2-2	5,5
2	7,5	260	190	300	1055	655
3-2	11,0	315	260	350	1267	763
3	11,0	315	260	350	1267	763
4-2	15,0	315	260	350	1345	841
4	15,0	315	260	350	1345	841
5-2	18,5	315	265	350	1467	919
5	18,5	315	265	350	1467	919
6-2	18,5	315	265	350	1545	997
6	22,0	360	275	350	1572	997
7-2	22,0	360	275	350	1650	1075
7	30,0	400	340	400	1745	1075
8-2	30,0	400	340	400	1823	1153
8	30,0	400	340	400	1823	1153
9-2	30,0	400	340	400	1901	1231
9	37,0	400	340	400	1901	1231
10-2	37,0	400	340	400	1979	1309
10	37,0	400	340	400	1979	1309

Movitec 60B, n = 1450 rpm

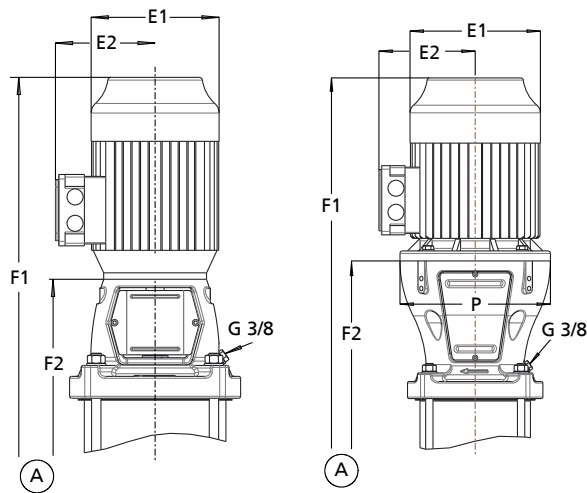

Table 30: Dimensions (motor flange version with clearance holes)

Number of stages	P <sub>N</sub> [kW]	E1 [mm]	E2 [mm]	P [mm]	Design	
					V(C/S)F	
					F1 [mm]	F2 [mm]
7	5,5	260	190	300	1445	1045
8	5,5	260	190	300	1523	1123
9	7,5	260	190	300	1636	1201
10	7,5	260	190	300	1714	1279

Dimensions of Movitec V(C/S)F      Dimensions of Movitec V(C/S)F

**i** Motor version V18

**i** Motor version V1

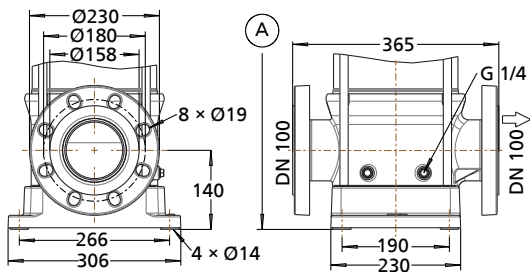

Fig. 54: Connections of Movitec VF, VSF

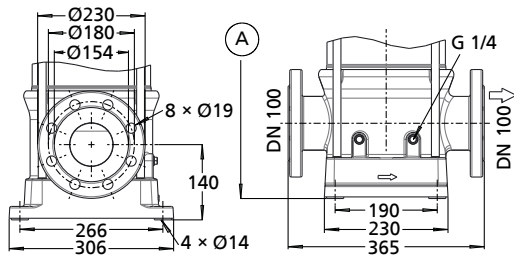
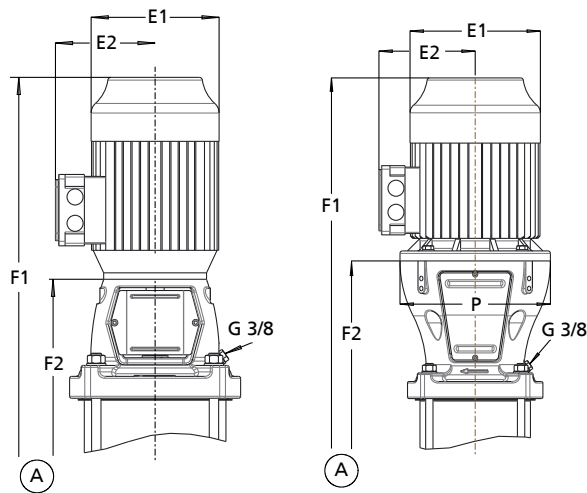

Fig. 55: Connections of Movitec VCF

Table 29: Dimensions (motor flange version with tapped holes)

Number of stages	P <sub>N</sub> [kW]	E1 [mm]	E2 [mm]	P [mm]	Design	
					V(C/S)F	
					F1 [mm]	F2 [mm]
3	2,2	200	155	-	961	643
4	3,0	200	155	-	1083	721
5	4,0	233	166	-	1114	799
6	4,0	233	166	-	1192	877

Movitec 60B, n = 2900 rpm



Dimensions of Movitec V(C/S)F      Dimensions of Movitec V(C/S)F

**i** Motor version V18

**i** Motor version V1

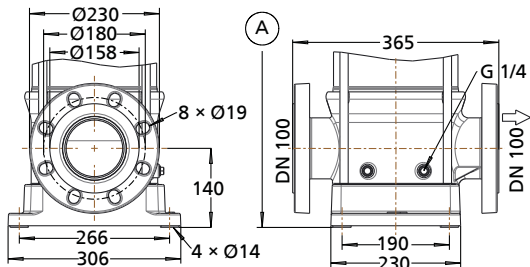

Fig. 56: Connections of Movitec VF, VSF (PN 16)

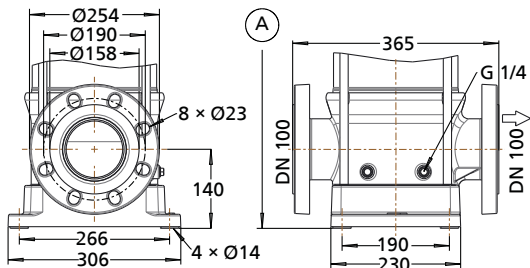

Fig. 57: Connections of Movitec VF, VSF (PN 25, PN 40)

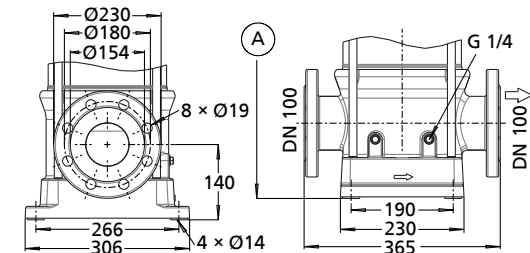

Fig. 58: Connections of Movitec VCF (PN 16)

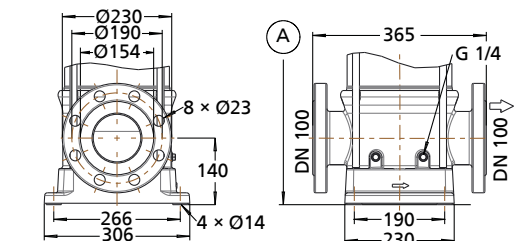

Fig. 59: Connections of Movitec VCF (PN 25, PN 40)

Table 31: Dimensions (motor flange version with tapped holes)

Number of stages	P <sub>N</sub> [kW]	E1 [mm]	E2 [mm]	P [mm]	Design V(C/S)F	
					F1 [mm]	F2 [mm]
	1-1	4,0	223	190	-	802

Table 32: Dimensions (motor flange version with clearance holes)

Number of stages	P <sub>N</sub> [kW]	E1 [mm]	E2 [mm]	P [mm]	Design V(C/S)F	
					F1 [mm]	F2 [mm]
	1	5,5	260	190	300	979
2-2	7,5	260	260	300	1055	655
2	11,0	315	260	350	1189	685
3-2	15,0	315	265	350	1267	763
3	18,5	315	265	350	1311	763
4-2	18,5	315	265	350	1389	841
4	22,0	360	275	350	1416	841
5-2	22,0	360	340	350	1494	919
5	30,0	400	340	400	1589	919
6-2	30,0	400	340	400	1667	997
6	30,0	400	340	400	1667	997
7-2	37,0	400	340	400	1745	1075
7	37,0	400	340	400	1745	1075
8-2	37,0	400	340	400	1823	1153
8	45,0	450	365	450	1863	1153
9-2	45,0	450	365	450	1941	1231

Movitec 90B, n = 1450 rpm

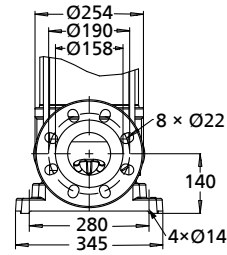
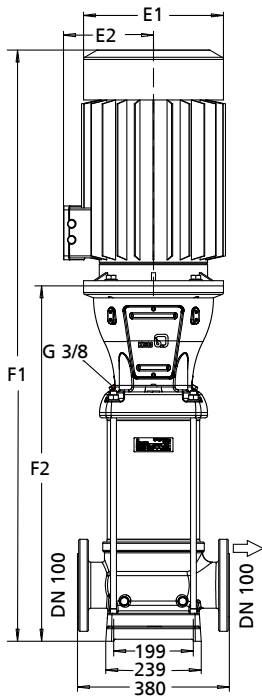

Fig. 63: Connections of Movitec VCF (PN 25, PN 40)

Table 33: Dimensions

Number of stages	P <sub>N</sub>	E1	E2	P	Design	
					V(C/S)F	
	[kW]	[mm]	[mm]	[mm]	F1	F2
5-2	5,5	260	190	300	1477	1077
5-1	5,5	260	190	300	1477	1077
5	5,5	260	190	300	1477	1077
6-2	5,5	260	190	300	1586	1186
6-1	5,5	260	190	300	1586	1186
6	5,5	260	190	300	1586	1186

Dimensions of Movitec V(C/S)F

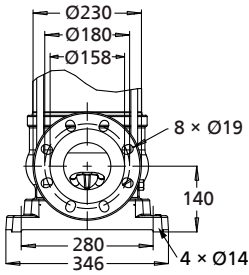

Fig. 60: Connections of Movitec VF, VSF (PN 16)

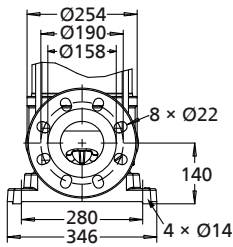

Fig. 61: Connections of Movitec VF, VSF (PN 25, PN 40)

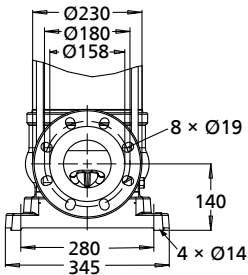
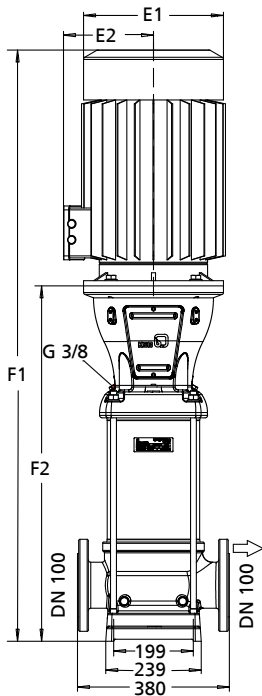

Fig. 62: Connections of Movitec VCF (PN 16)

Movitec 90B, n = 2900 rpm



Dimensions of Movitec V(C/S)F

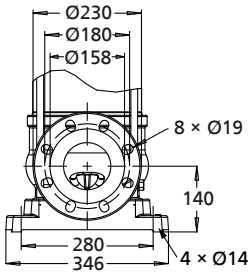

Fig. 64: Connections of Movitec VF, VSF(PN 16)

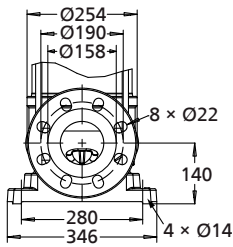

Fig. 65: Connections of Movitec VF, VSF (PN 25, PN 40)

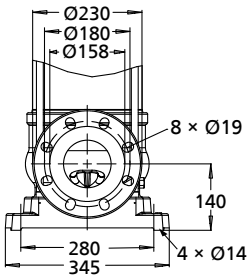

Fig. 66: Connections of Movitec VCF (PN 16)

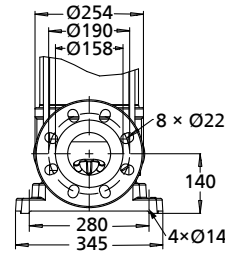
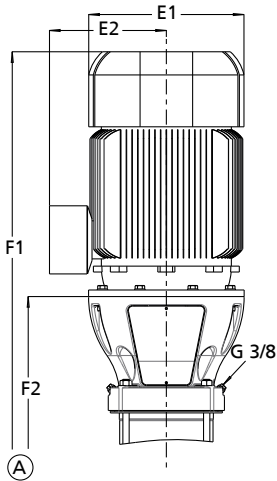

Fig. 67: Connections of Movitec VCF (PN 25, PN 40)

Table 34: Dimensions

Number of stages	P <sub>N</sub> [kW]	E1 [mm]	E2 [mm]	Design V(C/S)F	
				F1 [mm]	F2 [mm]
	1-1	5,5	260	190	1043
1	7,5	260	190	1041	641
2-2	11,0	315	260	1284	780
2-1	15,0	315	260	1284	780
2	15,0	315	260	1284	780
3-2	18,5	315	260	1437	889
3-1	22,0	360	275	1464	889
3	22,0	360	275	1464	889
4-2	30,0	400	340	1668	998
4-1	30,0	400	340	1668	998
4	30,0	400	340	1668	998
5-2	37,0	400	340	1777	1107
5-1	37,0	400	340	1777	1107
5	37,0	400	340	1777	1107
6-2	45,0	450	365	1926	1216
6-1	45,0	450	365	1926	1216
6	45,0	450	365	1926	1216

Movitec 125B, n = 2900 rpm



Dimensions of Movitec V(C/S)F

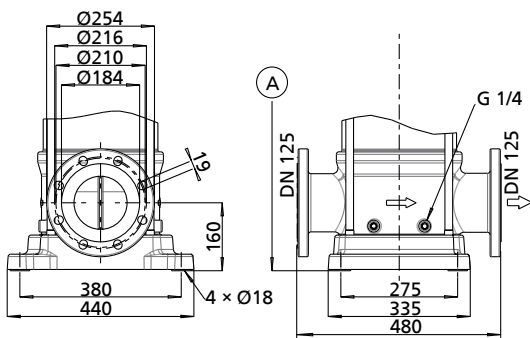

Fig. 68: Connections of Movitec VF, VSF, VCF (PN 16)

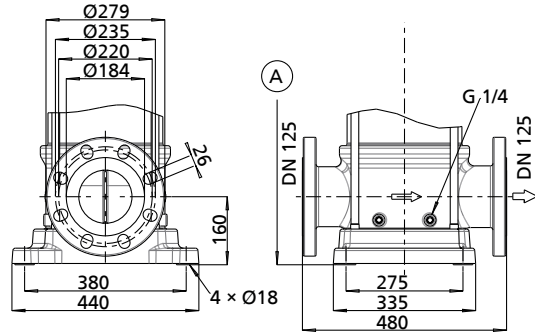

Fig. 69: Connections of Movitec VF, VSF, VCF (PN 25, PN 40)

Table 35: Dimensions

Number of stages	P <sub>N</sub> [kW]	E1 [mm]	E2 [mm]	Design	
				V(C/S)F	
				F1 [mm]	F2 [mm]
1	15,0	315	260	1243	740
2-2	18,5	315	260	1417	867
2-1	22,0	360	275	1444	867
2	30,0	400	340	1539	867
3-2	30,0	400	340	1669	994
3-1	37,0	400	340	1669	994
3	37,0	400	340	1669	994
4-2	45,0	450	365	1829	1121



Movitec LHS, n = 2900 rpm

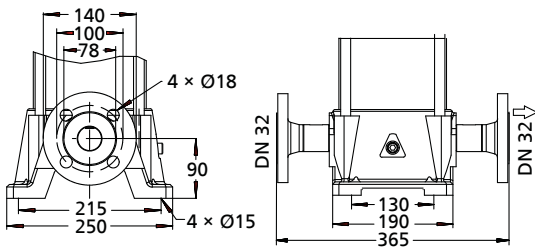
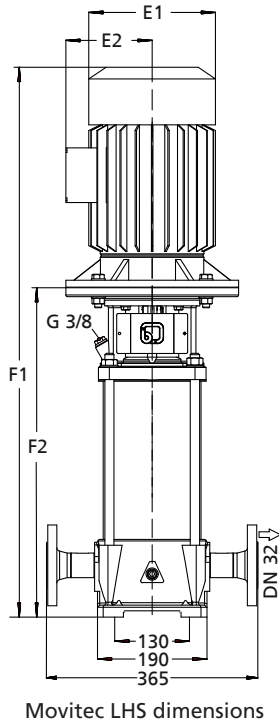

Fig. 70: Movitec LHS connections

Table 36: Dimensions

Number of stages	E1	E2	F1	F2
	[mm]	[mm]	[mm]	[mm]
10	260	190	928	599
12	260	190	1015	658
14	315	260	1250	718
16	315	260	1310	808
18	315	260	1369	867
20	315	260	1429	927

### Installation information

Standard:

- Vertical installation

Optional:

- Horizontal installation

(for motor ratings up to and including 7.5 kW in systems where the installation conditions do not allow vertical installation)

### Movitec 2(L)B, 4(L)B, 6(L)B

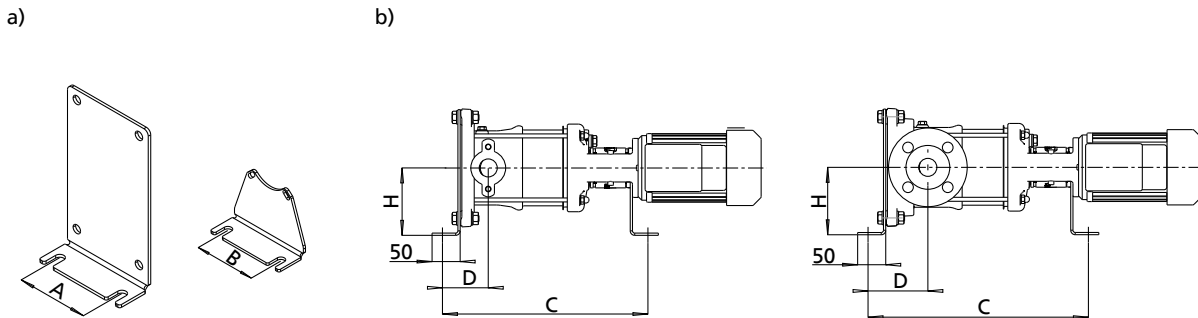

Fig. 71: a) Pump bracket b) Pump set

Table 37: Installation dimensions of the pump bracket as a function of the motor rating

P <sub>N</sub> [kW]	A [mm]	B [mm]	C <sup>37)</sup> [mm]	D		H [mm]	[kg]	Mat. No.
				-, E, T, V [mm]	F [mm]			
0.37/0.55 (2-pole)	100	100	F2+49	82	107	120	2	48895741
0.75/1.10 (2-pole)	100	100	F2+49	82	107	120	2,3	48895742
1.50/2.20 (2-pole)	100	100	F2+47	82	107	120	2,5	48895743
3.00/4.00 (2-pole)	100	100	F2+47	82	107	120	3	48895744
5.50/7.50 (2-pole)	100	210	F2-18	82	107	170	3,5	48895745

### Movitec 10(L)B, 15(L)B/C

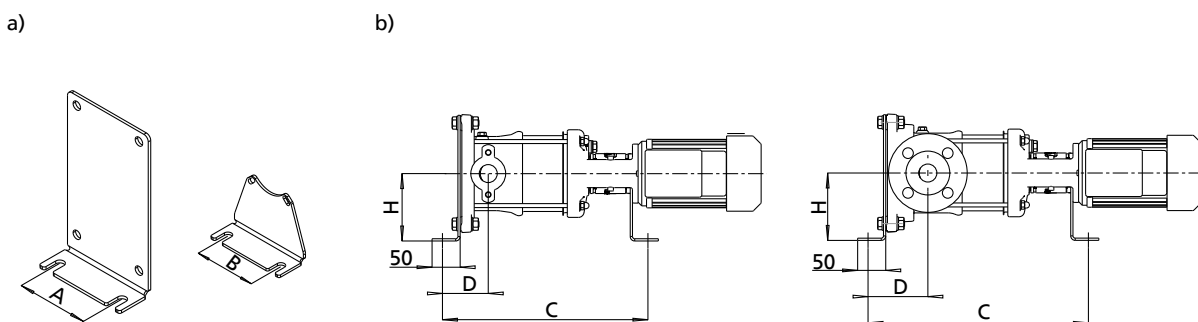

Fig. 72: a) Pump bracket b) Pump set

<sup>37)</sup> F2: See dimensions

**Table 38:** Installation dimensions of the pump bracket as a function of the motor rating

P <sub>N</sub>	A	B	C <sup>37)</sup>	D		H	[kg]	Mat. No.
				- , E, F, T, V 10B -, E 15B	F, T, V 15B			
[kW]	[mm]	[mm]	[mm]	[mm]	[mm]	[mm]		
0.75/1.10 (2-pole)	130	130	F2+49	111,5	121,5	140	2,786	01338571
0.55/0.75 (4-pole)								
1.50/2.20 (2-pole)	130	130	F2+47	111,5	121,5	140	2,799	01338572
1.10/1.50 (4-pole)								
3.00/4.00 (2-pole)	130	130	F2+47	111,5	121,5	140	2,766	01338573
2.20/4.00 (4-pole)								
5.50/7.50 (2-/4-pole)	130	210	F2-18	111,5	121,5	170	3,116	01338574

**Movitec 25B**

a)

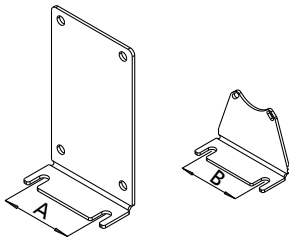

b)

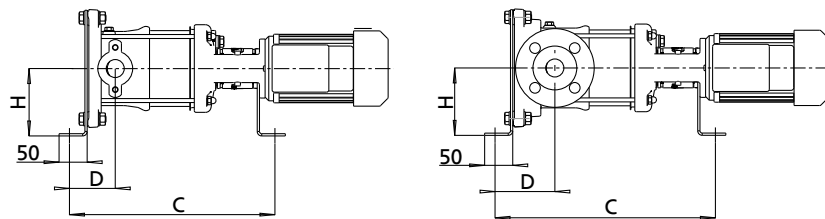

**Fig. 73:** a) Pump bracket b) Pump set

**Table 39:** Installation dimensions of the pump bracket as a function of the motor rating

P <sub>N</sub>	A	B	C <sup>37)</sup>	D	H	[kg]	Mat. No.
1.50/2.20 (2-pole)	170	180	F2+47	136,5	170	2,799	01498693
3.00/4.00 (2-pole)	170	180	F2+47	136,5	170	2,799	01498694
5.50/7.50 (2-pole)	170	210	F2-16	136,5	170	3,116	01498695

**Movitec 40B, 60B**

a)

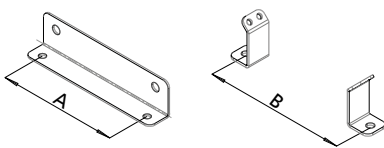

b)

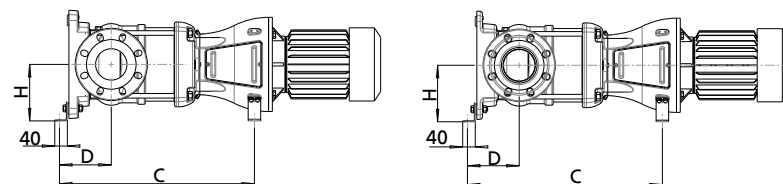

**Fig. 74:** a) Pump bracket b) Pump set

**Table 40:** Installation dimensions of the pump bracket as a function of the motor rating

P <sub>N</sub>	A	B	C <sup>37)</sup>	D	H	[kg]	Mat. No.
3.00/4.00 (2-pole)	190	180	F2-16	165	180	2,799	01582128
2.20/4.00 (4-pole)							
5.50/7.50 (2-/4-pole)	190	250	F2-20	165	180	3,116	01582129

**Movitec 90B**

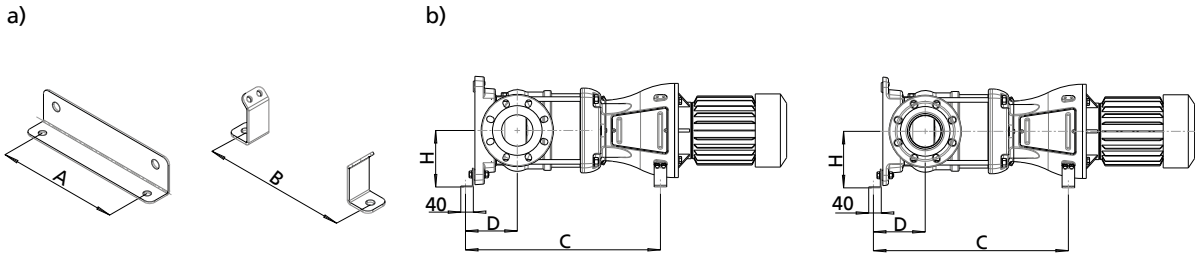

Fig. 75: a) Pump bracket b) Pump set

Table 41: Installation dimensions of the pump bracket as a function of the motor rating

$P_N$ [kW]	A [mm]	B [mm]	C <sup>37)</sup> [mm]	D [mm]	H [mm]	[kg]	Mat. No.
5.50/7.50 (2-/4-pole)	210	250	F2-16	165	180	3,8	48895593

**Terminal box positions**

Table 42: Top view of terminal box positions

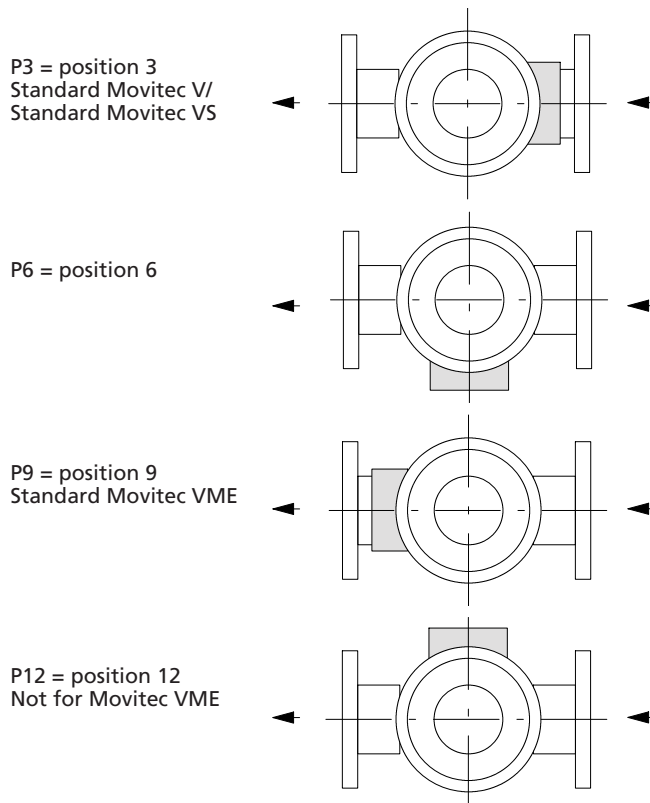

**Scope of supply**

Depending on the model, the following items are included in the scope of supply:

- Pump
- Electric motor

**Accessories**

Possible accessories:

- Frequency inverter, see type series booklet PumpDrive (4074.5)
- PumpMeter, see type series booklet (4072.5)

**Accessories**

Possible accessories:

- Frequency inverter, see type series booklet PumpDrive (4074.5)

General assembly drawing with list of components

Movitec 2(L)B, 4(L)B, 6(L)B

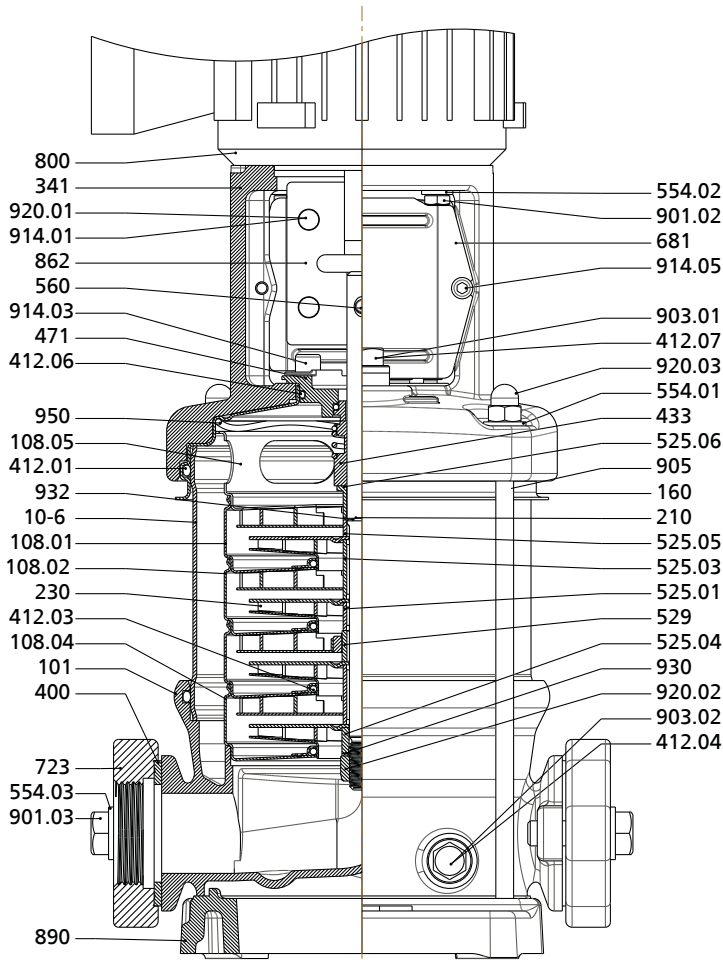

Fig. 76: General assembly drawing of Movitec 2(L)B, 4(L)B, 6(L)B

Table 43: List of components

Part No.	Description	Part No.	Description
10-6	Pump shroud	560	Pin
101	Pump casing	681	Coupling guard
108.01/.02/.04/.05	Stage casing	723	Flange
160	Cover	800	Motor
210	Shaft	862	Coupling
230	Impeller	890	Baseplate
341	Drive lantern	901.02/.03	Hexagon head bolt
400	Gasket	903.01	Vent plug
412.01/.03/.04/.06/.07	O-ring	905	Tie bolt
433	Mechanical seal	914.01/.03/.05	Hexagon socket head cap screw
471	Seal cover	920.01/.02/.03	Nut
525.01/.03/.04/.05/.06	Spacer sleeve	930	Safety device
529	Bearing sleeve	932	Circlip
554.01/.03	Washer	950	Spring

Movitec 10(L)B

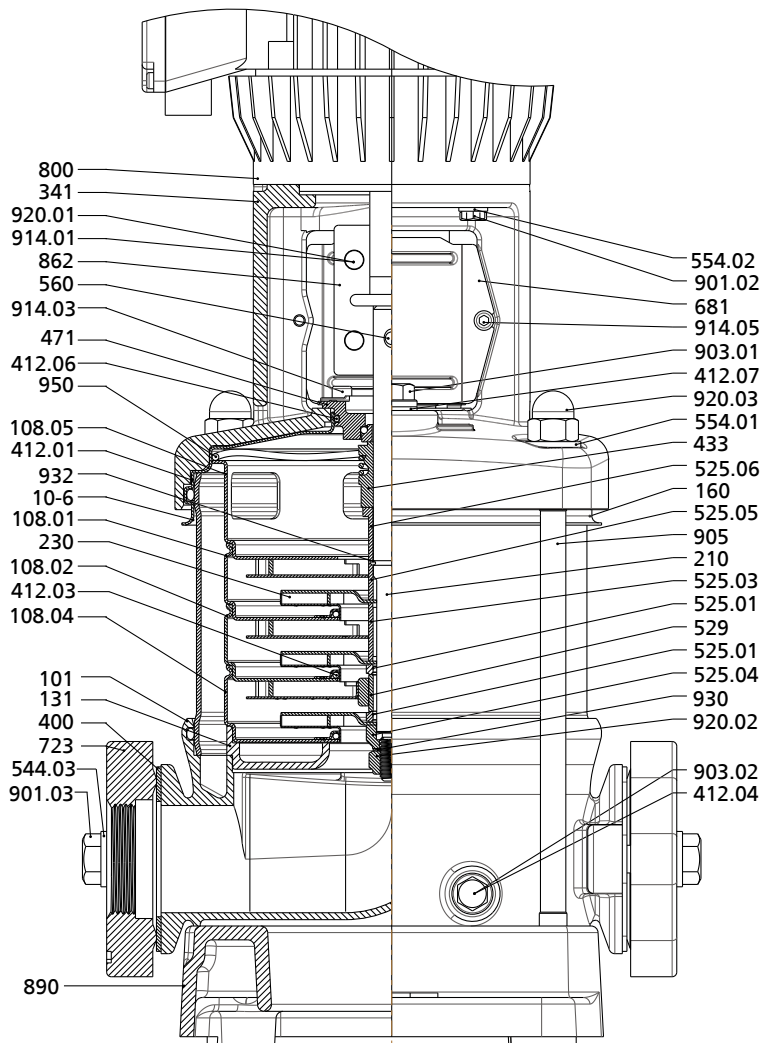

Fig. 77: General assembly drawing of Movitec 10(L)B

Table 44: List of components

Part No.	Description	Part No.	Description
10-6	Pump shroud	554.01/.02	Washer
101	Pump casing	560	Pin
108.01/.02/.04/.05	Stage casing	681	Coupling guard
131	Inlet ring	723	Flange
160	Cover	800	Motor
210	Shaft	862	Coupling
230	Impeller	890	Baseplate
341	Drive lantern	901.02/.03	Hexagon head bolt
400	Gasket	903.01/.02	Vent plug
412	O-ring	905	Tie bolt
433	Mechanical seal	914.01/.03/.05	Hexagon socket head cap screw
471	Seal cover	920.01/.02/.03	Nut
525.01/.03/.04/.05/.06	Spacer sleeve	930	Safety device
529	Bearing sleeve	932	Circlip
544.03	Threaded bush	950	Spring

Movitec 15(L)C

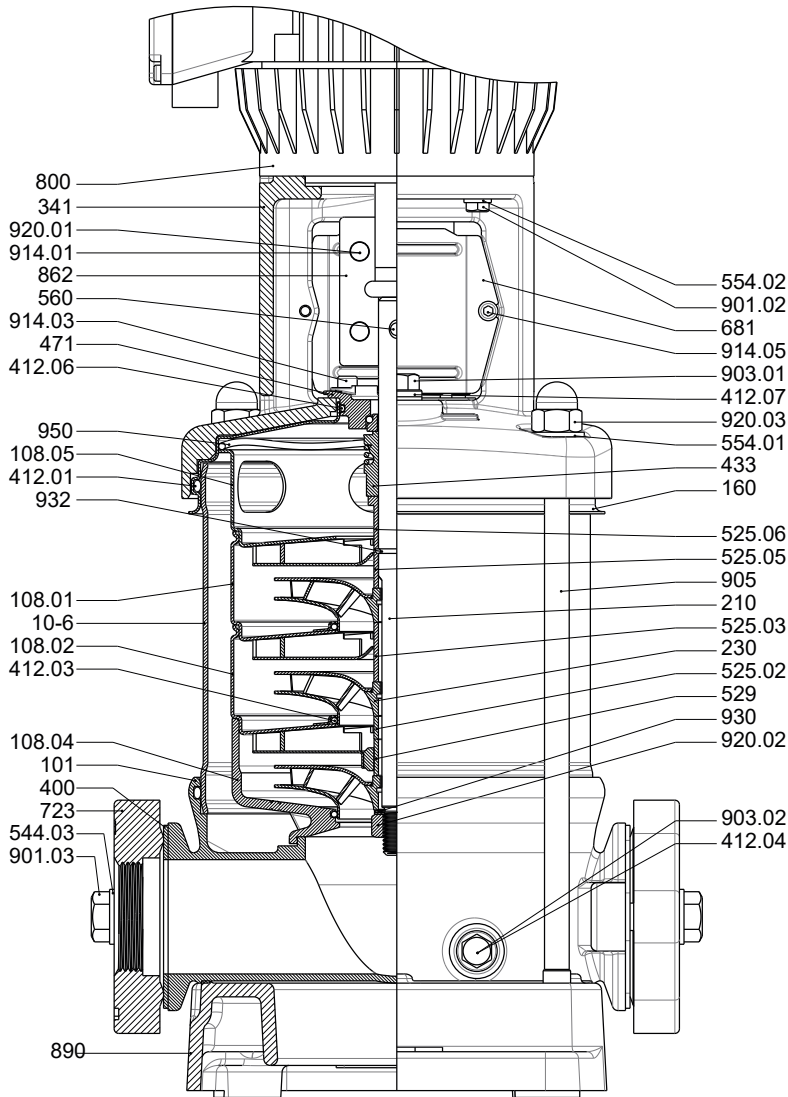

Fig. 78: General assembly drawing of Movitec 15(L)C

Table 45: List of components

Part No.	Description	Part No.	Description
10-6	Pump shroud	560	Pin
101	Pump casing	681	Coupling guard
108.01/.02/.04/.05	Stage casing	723	Flange
160	Cover	800	Motor
210	Shaft	862	Coupling
230	Impeller	890	Baseplate
341	Drive lantern	901.02/.03	Hexagon head bolt
400	Gasket	903.01/.02	Vent plug
412.01/.03/.04/.06/.07	O-ring	905	Tie bolt
433	Mechanical seal	914.01/.03/.05	Hexagon socket head cap screw
471	Seal cover	920.01/.02/.03	Nut
525.02/.03/.05/.06	Spacer sleeve	930	Safety device
529	Bearing sleeve	932	Circlip
544.03	Threaded bush	950	Spring
554.01/.02	Washer		

1798.52/15-EN

Movitec 25B, 40B, 60B

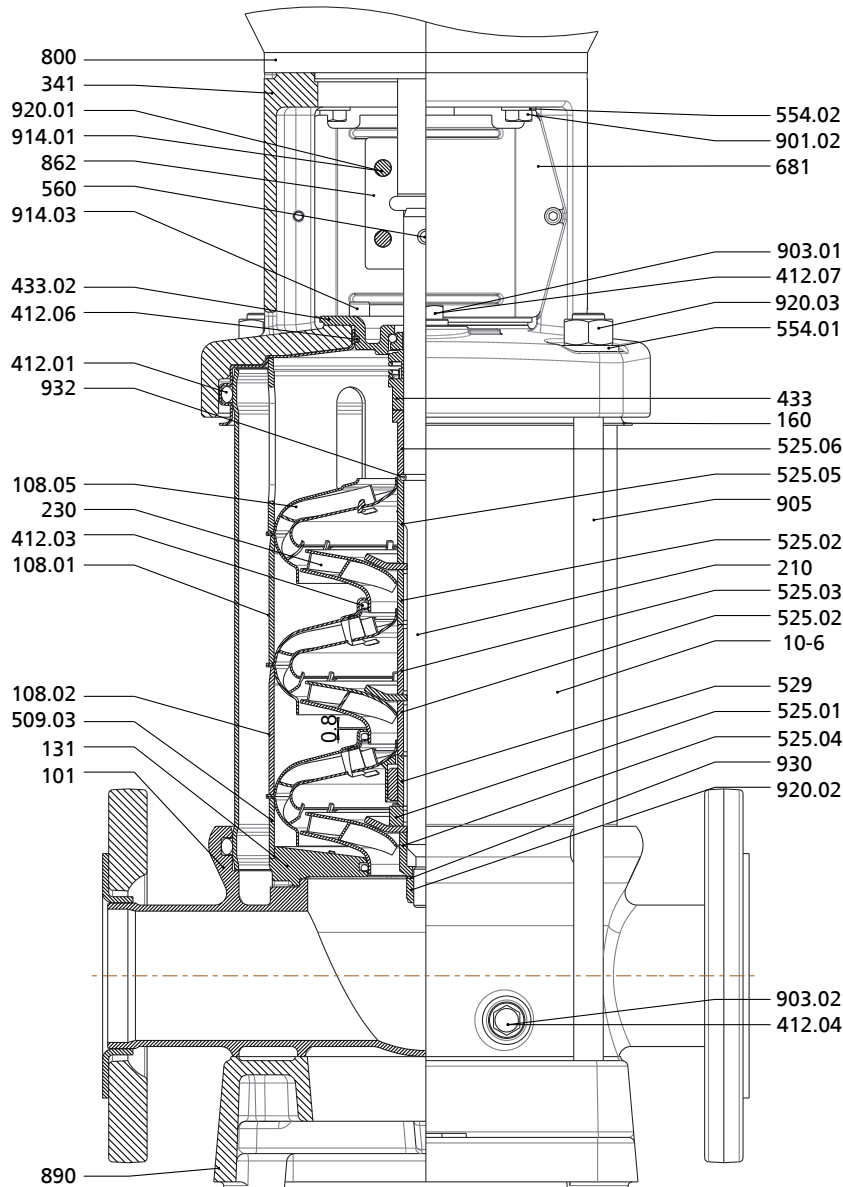

Fig. 79: General assembly drawing of Movitec 25B, 40B, 60B

Table 46: List of components

Part No.	Description	Part No.	Description
10-6	Pump shroud	554.01/.02	Washer
101	Pump casing	560	Pin
108.01/.02/.05	Stage casing	681	Coupling guard
131	Inlet ring	800	Motor
160	Cover	862	Coupling
210	Shaft	890	Baseplate
230	Impeller	901.02	Hexagon head bolt
341	Drive lantern	903.01/.02	Vent plug
412.01/.03/.04/.06/.07	O-ring	905	Tie bolt
433.02	Mechanical seal	914.01/.03	Hexagon socket head cap screw
509.03	Intermediate ring	920.01/.02/.03	Nut
525.01/.02/.03/.04/.05/.06	Spacer sleeve	930	Safety device
529	Bearing sleeve	932	Circlip
544	Threaded bush		



Movitec 90B

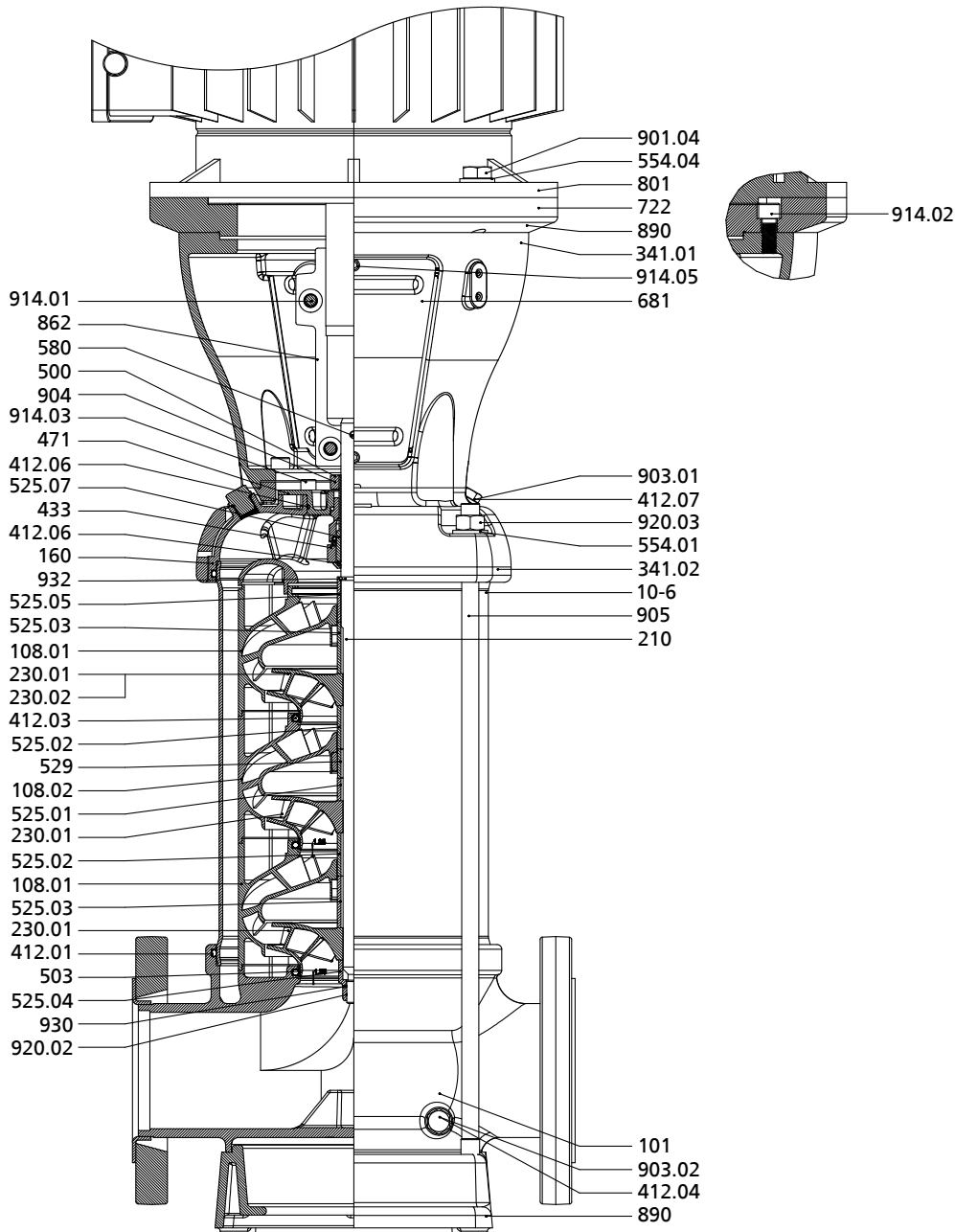

Fig. 80: General assembly drawing of Movitec 90B

Table 47: List of components

Part No.	Description	Part No.	Description
10-6	Pump shroud	580	Cap
101	Pump casing	681	Coupling guard
108.01/.02	Stage casing	722	Stub flange
160	Cover	801	Flanged motor
210	Shaft	862	Coupling
230.01/.02	Impeller	890	Baseplate
341.01/.02	Drive lantern	901.04	Hexagon head bolt
412.01/.03/.04/.06/.07	O-ring	903	Vent plug
433	Mechanical seal	904	Grub screw
471	Seal cover	905	Tie bolt
500	Ring	914.01/.02/.03/.05	Hexagon socket head cap screw
503	Impeller wear ring	920.02/.03	Nut

1798.52/15-EN

Part No.	Description	Part No.	Description
525.01/.02/.03/.04/.05/.07	Spacer sleeve	930	Safety device
529	Bearing sleeve	932	Circlip
544.01/.04	Threaded bush		

Movitec 125B

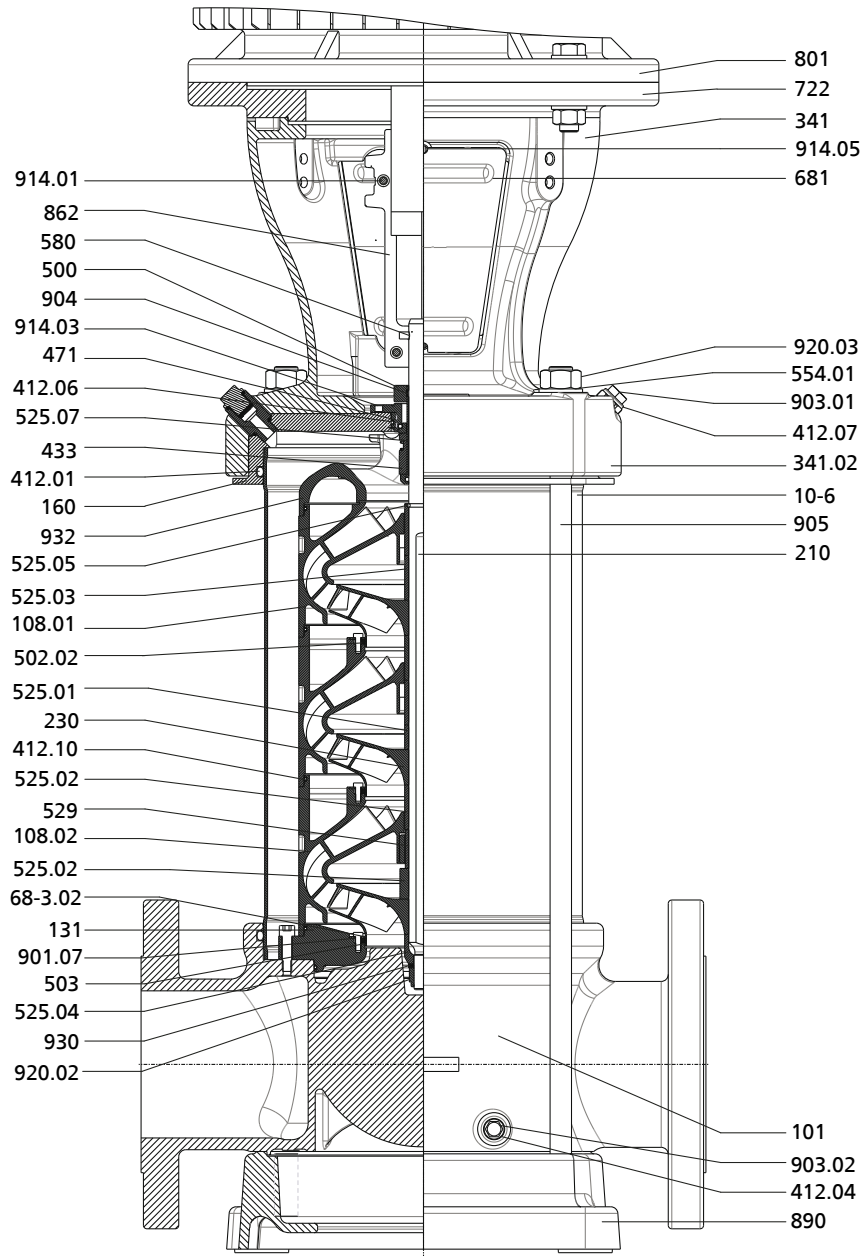

Fig. 81: General assembly drawing of Movitec 125B

Table 48: List of components

Part No.	Description	Part No.	Description
10-6	Pump shroud	554.01	Washer
101	Pump casing	580	Cap
108.01/.02	Stage casing	68-3.02	Cover plate
131	Inlet ring	681	Coupling guard
160	Cover	722	Stub flange
210	Shaft	801	Flanged motor
230	Impeller	862	Coupling
341.02	Drive lantern	890	Baseplate
412.01/.04/.06/.07/.10	O-ring	901.07	Hexagon head bolt
433	Mechanical seal	903.01/.02	Screw plug
471	Seal cover	904	Grub screw
500	Ring	905	Tie bolt
502.02	Casing wear ring	914.01/.03/.05	Hexagon socket head cap screw

1798.52/15-EN

Part No.	Description	Part No.	Description
503	Impeller wear ring	920.02/.03	Nut
525.01/.02/.03/.04/.05/.07	Spacer sleeve	930	Safety device
529	Bearing sleeve	932	Circlip

Movitec LHS

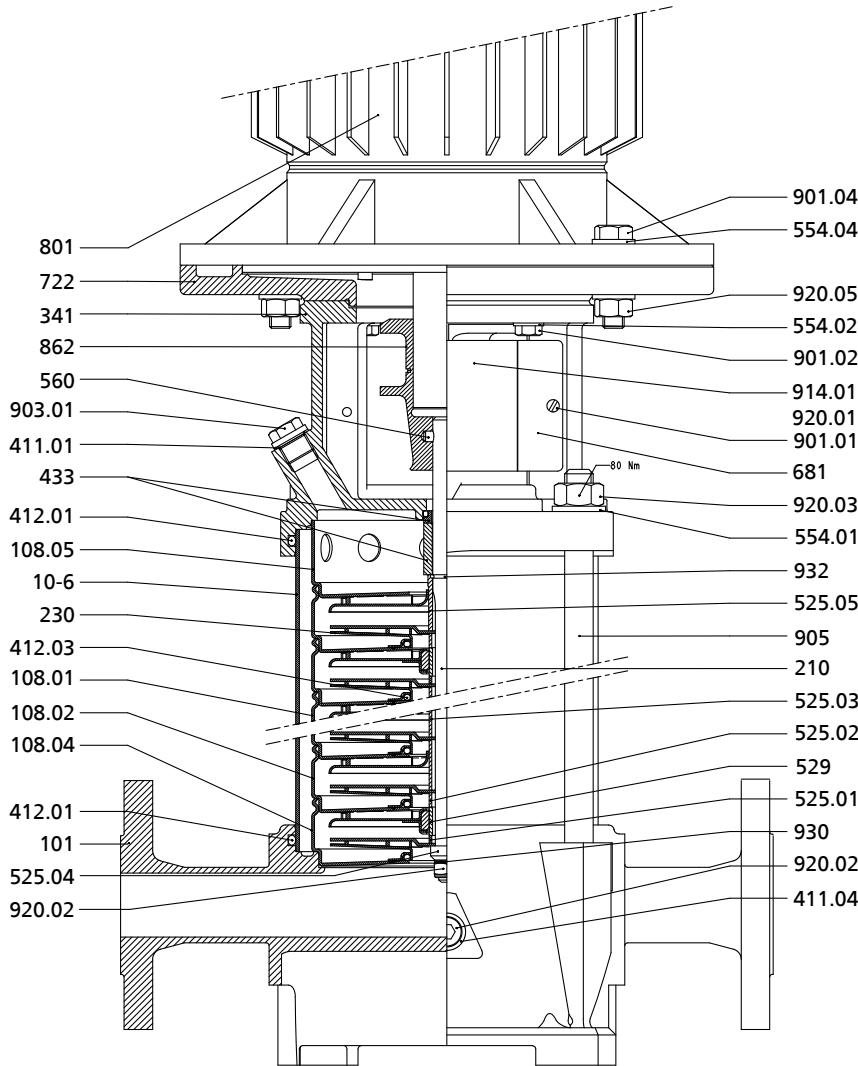

Fig. 82: General assembly drawing of Movitec LHS

Table 49: List of components

Part No.	Description	Part No.	Description
10-6	Pump shroud	560	Pin
101	Pump casing	681	Coupling guard
108.01/.02/.04/.05	Stage casing	722	Stub flange
210	Shaft	801	Flanged motor
230	Impeller	862	Coupling
341	Drive lantern	901.01/.02/.04	Hexagon head bolt
411.01/.03	Joint ring	903.01	Vent plug
412.01/.03	O-ring	905	Tie bolt
433	Mechanical seal	914.01	Hexagon socket head cap screw
525.01/.02/.03/.04/.05	Spacer sleeve	920.01/.02/.03/.05	Nut
529	Bearing sleeve	930	Safety device
554.01/.02/.04	Washer	932	Circlip







**KSB SE & Co. KGaA**  
Johann-Klein-Straße 9 • 67227 Frankenthal (Germany)  
Tel. +49 6233 86-0  
[www.ksb.com](http://www.ksb.com)